

EZGO

GENUINE OEM PARTS



LIVE LARGER
Parts Catalog | 13th Edition

Order E-Z-GO Genuine Parts & Accessories 24 hours a day, 7 days a week with TAP!

allows active E-Z-GO account holders to view E-Z-GO parts, manuals, check price and availability, and place orders online. No more separate passwords. Access the site from TSV Connect today.

TAP will allow you to:

- Place orders online, no hold times
- View TSV parts manuals with illustrations and part numbers
- Check price and parts availability
- Search for products by part numbers
- Quickly add multiple parts to your cart with quick add and upload
- Drop ship and post-date orders

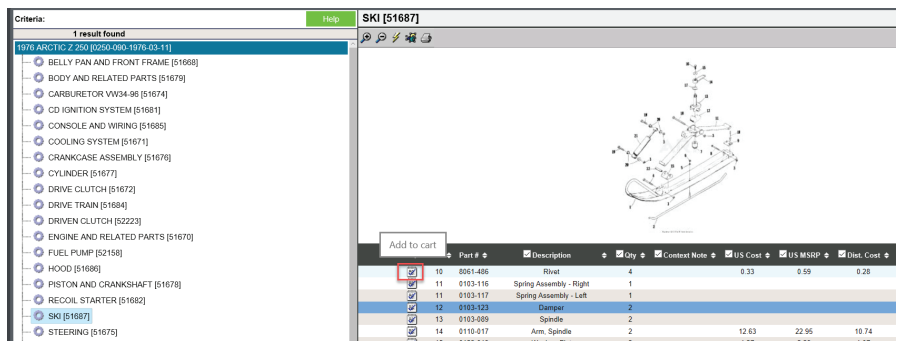
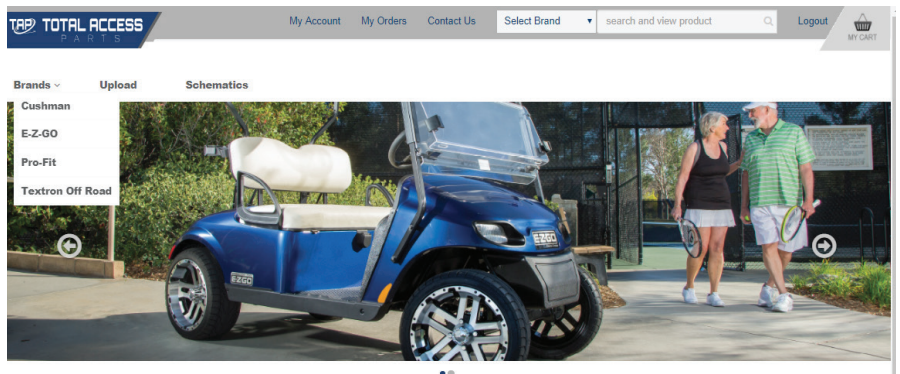

Log on today and see what else **TAP** can do.

Please contact us at ordertsvparts@textron.com or 888-438-3946 for E-Z-GO, Textron Off Road & Pro-Fit or at 800-848-1636 for Jacobsen.



2 Table of Contents



4 Manuals & Owner's Guides



14 TXT



96 RXV



160 EXPRESS

CONTENTS

CONTENTS	1-3
SERVICE MANUALS	4-13
TXT 2014-CURRENT	14-95
ACCELERATOR	16-17
Switches	17
BATTERY & CHARGERS	18-25
Battery Watering System & Components	19
Cables & Wiring	19-21
Cords	21-22
Chargers	22
Control Boards & Timers	22
Dischargers	23
Fuses, Diodes & Relays	23
Hold Downs & Straps	23
Lithium	24-25
BODY & TRIM	26-37
Access Panel	27
Bagwell Liner	27
Body & Cowls	28
Bumpers & Brushguards	29-30
Fender Flares & Mud Guards	30-31
Floor Mats	32
Frames	32
Front Shields	33-34
Instrument Panel	34-35
Kick Plate	35
Rocker Panels & Sill Plates	36-37
Scuff Guards	37
Restoration	37
Spray Paint	37
CLUTCHES	38-40
Belts	39
Drive Clutches	39
Driven Clutches	40
Packages	40
DIRECTION SELECTOR	41-43
Cables & Linkage	42
Direction Selector Assembly	42
Switches	42-43
ELECTRIC MOTOR	44-46
Motors & Components	45-46
ELECTRICAL SYSTEM	47-53
Chargers	48
Gauges	48
Harnesses	48-49
Ignition Switches	49-50
Lights	50
Solenoids	51

Speed Controller	51
Speed Controller Components	52
Switches	53
Turn Signals	53
Voltage Regulator	53
ENGINE	54-62
Air Filter	55
Belts	55
Carburetor & Choke	56
Diagnostic Tool	56
Engine Assembly	56-59
Housing & Components	60
Muffler	60
Oil Filters	61
Starter Generator	62
FRONT SUSPENSION & STEERING	63-70
Leaf Springs	64
Spindles & Hubs	64-66
Steering Columns & Components	66-67
Steering Rack & Components	67-69
Tie Rods	70
FUEL SYSTEM	71-73
Fuel Filters	72
Fuel Pumps	72
Fuel Tanks	72-73
Sending Units	73
Siphon Tubes	73
ON THE COURSE	74-75
Bag Attachments	75
Sand Bottles & Buckets	75
Tow Bar	75
REAR AXLE	76-79
Axle Assemblies	77
Rear Axle Asm	77
Rear Axle Components	78-79
REAR SUSPENSION	80-84
Leaf Springs	81-83
Mounting Plates & Hardware	83
Shock Absorbers	83-84
SEATING	85-90
Hip Restraints	86
Premium Seat Asms	86
Seat Backs	86
Seat Bottoms	87-88
Seat Components	88
Seat Covers	89
Seat Packages	90

SPECIALTY TOOLS	91-92
Diagnostic Tools	92
TOPS, WINDSHIELDS & PROTECTION	93-95
54" Top Kits	94
80" Top Kits	94
116" Top Kits	95
RXV 2008-CURRENT	96-159
ACCELERATOR	98-99
Switches	99
BATTERY & CHARGERS	100-103
Battery Watering System & Components	101
Cables & Wiring	101-102
Chargers	102-103
Hold Downs & Straps	103
Lithium	103
BODY & TRIM	104-114
Access Panel	104
Bagwell Liner	104
Body & Cowls	106-107
Bumpers & Brushguards	108-109
Floor Mats	110
Frames	110
Front Shields	111
Instrument Panel	111-112
Mirrors	113
Reflectors	113
Rocker Panels & Sill Plates	113
Scuff Guards	114
Stretch Kits	114
CLUTCHES	115-117
Belts	116
Drive Clutches	116
Driven Clutches	116
Packages	117
DIRECTION SELECTOR	118-119
Cables & Linkage	119
ELECTRIC MOTOR	120-121
Motors & Components	121
ELECTRICAL SYSTEM	122-128
DC/DC Converters	123
Fuses, Diodes & Relays	123
Gauges	123
Harnesses	123-124
Horns	124
Ignition Switches	124-125
Lights	125-126
Solenoids	126

Speed Controller	127
Turn Signals	128
Voltage Regulator	128
ENGINE	129-134
Air Filter	130
Belts	130
Carburetor & Choke	130
Diagnostic Tool	130
Engine Assembly	131
Engine Components	131-133
Housing & Components	133
Muffler	134
FRONT SUSPENSION & STEERING	135-138
A-Arm Asm & Suspension	136
Spindles & Hubs	136-137
Steering Columns & Components	137
Steering Rack & Components	137-138
FUEL SYSTEM	139-140
Fuel Filters	140
Fuel Pumps	140
ON THE COURSE	141-143
Bag Attachments	142
Sand Bottles & Buckets	142-143
Tow Bar	143
REAR AXLE	144-150
Axle Assemblies	145
Rear Axle Components	145-147
Rear Suspension	
Leaf Springs	149
Mounting Plates & Hardware	149
Shock Absorbers	150
SEATING	151-154
Hip Restraints	152
Seat Backs	152
Seat Bottoms	153
Seat Covers	154
Seat Packages	154
Premium Front Seats	154
SPECIALTY TOOLS	155-156
Diagnostic Tools	156
TOPS, WINDSHIELDS & PROTECTION	157-159
54" Top Kits	158
80" Top Kits	159
EXPRESS 2014-CURRENT	160-220
ACCELERATOR	162-163
Switches	163
BATTERY & CHARGERS	164-167
Cables & Wiring	165

Chargers	165
Hold Downs & Straps	166
Lithium	166
BODY & TRIM	168-178
Access Panel	169
Bagwell Liner	169
Bumpers & Brushguards	169-170
Floor Mats	170
Body & Cows	172-173
Frames	174
Front Shields	174
Glove Boxes	175
Instrument Panel	175-176
Kick Plate	176
Mirrors	176
Nerf Bar	176
Rocker Panels & Sill Plates	177
Scuff Guards	177
Seat Pods	178
CLUTCHES	179-180
Belts	180
Driven Clutches	180
DIRECTION SELECTOR	181-182
Cables & Linkage	182
Direction Selector Assembly	182
ELECTRIC MOTOR	183-185
Motors & Components	184-185
ELECTRICAL SYSTEM	186-191
Gauges	187
Harnesses	188
Ignition Switches	188-189
Lights	189-190
Solenoids	190
Speed Controller	190-191
Switches	191
Turn Signals	191
Voltage Regulator	191
ENGINE	192-195
Carburetor & Choke	193
Engine Assembly	193
Engine Components	193-194
Muffler	194
Oil Filters	194
Starter Generator	194-195
FRONT SUSPENSION & STEERING	196-201
A-Arm Asm & Suspension	197
Front Axle	197
Leaf Springs	197
Spindles & Hubs	198

Steering Columns & Components	199-200
Steering Wheel	201
Tire Rods	201
FUEL SYSTEM	202-203
Fuel Filters	203
Fuel Pumps	203
Fuel Tanks	203
Sending Units	203
Siphon Tubes	203
REAR AXLE	204-207
Axle Assemblies	205
Rear Axle Asm	205
Rear Axle Components	206-207
REAR SUSPENSION	208-211
Leaf Springs	209
Mounting Plates & Hardware	210
Shock Absorbers	210-211
SEATING	212-216
Hip Restraints	213
Seat Bottoms	213-214
Seat Components	214-215
Seat Covers	216
Seat Packages	216
SPECIALTY TOOLS	217-218
Diagnostic Tools	218
TOPS, WINDSHIELDS & PROTECTION	219-220
82" Top Kits	220
116" Top Kits	220
INDEX	

MANUALS & OWNER'S GUIDES

Technical Publications : 2020 MODEL YEAR REVISED: 10 FEB 20				
	FINAL ASSEMBLY	PARTS MANUAL	REPAIR MANUAL	OWNER'S GUIDE
	Base P/N	Manual #	Manual #	Manual #
E-Z-GO VEHICLES				
(model year begins 1 July)				
2FIVE, 2 PASSENGER 48V AC (ENGLISH) 2FIVE, 2 PASSENGER 48V AC (SPANISH)	643508	647698	647702/647702S	646299
2FIVE, 4 PASSENGER 48V AC (ENGLISH) 2FIVE, 4 PASSENGER 48V AC (SPANISH)	643509	647698	647702/647702S	646299
2 FIVE, INTL 2&4 PASS 48V AC (ENGLISH) 2FIVE, INTL 2&4 PASS 48V AC (SPANISH)	643509	647698	647702/647702S	646590
RXV FLEET 48V AC (ENGLISH) RXV FLEET 48V AC (SPANISH)	638540	647696	647700 647700S	646285
RXV FREEDOM 48V AC	638542	647696	647700	646285
RXV SHUTTLE 2+2 48V AC	638546	647696	647700	646285
RXV SHUTTLE 2+2 ELEC HIGH SPEED	638539	647696	647700	646285
RXV FLEET ELITE	654597	660325	660328/ 660328S	657039
RXV FREEDOM ELITE	654598	660326	660329	657040
RXV SHUTTLE 2+2 ELITE	654599	660327	660330	657041
RXV SHUTTLE 2+2 ELITE HS	654600	660327	660330	657041
RXV G FLEET (ENGLISH) RXV G FLEET (SPANISH)	638541	647697	647701 647701S	646286
RXV G FREEDOM	638543	647697	647701	646286
RXV G SHUTTLE 2+2	638545	647697	647701	646286
RXV SHUTTLE 2+2 CARB HIGH SPEED	638547	647697	647701	646286
TXT ELECTRIC FLEET (ENGLISH) TXT ELECTRIC FLEET (SPANISH)	625110	634464	634466 634466S	633137
TXT ELECTRIC FREEDOM	625112	634464	634466	633138
TXT ELECTRIC 2+2	625114	634464	634466	633139
TXT 72V FREEDOM	658071	658755	658758	658568
TXT FLEET ELITE	654601	660331	660334	657087
TXT FREEDOM ELITE	654602	660332	660335	657088
TXT SHUTTLE 2+2 ELITE	654603	660333	660336	657089
TXT GAS FLEET-TS2 (ENGLISH) TXT GAS FLEET-TS2 (SPANISH)	625111	634465	634468 634468S	633140
TXT GAS FREEDOM - TS2	625113	634465	634468	633141
TXT GAS 2+2 - TS2	625115	634465	634468	633142
TXT VALOR GAS	628444	653637	653635	628442

Technical Publications : 2020 MODEL YEAR REVISED: 10 FEB 20

	FINAL ASSEMBLY	PARTS MANUAL	REPAIR MANUAL	OWNER'S GUIDE
	Base P/N	Manual #	Manual #	Manual #
E-Z-GO VEHICLES				
(model year begins 1 July)				
EXPRESS S4 48V	618861	625478	625620	622014
EXPRESS S4 TS2	618862	625479	625617	622022
EXPRESS S4 HO ELEC	635082	635086	635085	635080
EXPRESS S6 E	618867	625480	625621	622013
EXPRESS S6 TS2	618868	625481	625622	622009
EXPRESS L6 E	618865	625482	625621	622013
EXPRESS L6 TS2	618866	625483	625622	622009
EXPRESS S6 72V	671113	677966		672073
EXPRESS L6 72V	671224	677968		672074
EXPRESS 4x4	682718	686459		683905
SHOP REBUILD MANUAL - STORAGE PLANNING MANUAL - HANDHELD DIAGNOSTICS GUIDES				
TUG AXLE REBUILD		641236		
KAWASAKI ENGINE REBUILD		608172		
2009 DANA AXLE REBUILD		610987		
FUJI TRANSAXLE REBUILD		628519		
FUJI AXLE REBUILD FOR KAWASAKI POWER		611374		
POWERWISE QE 36 VOLT BATTERY CHARGER		612746		
POWERWISE QE 48 VOLT BATTERY CHARGER		612747		
STORAGE PLANNING GUIDE		608259		
RXV & 2Five HANDHELD DIAGNOSTICS GUIDE		614804		
RXV & 2Five CURTIS 1313 HANDHELD DIAGNOSTICS GUIDE		627348		
RXV CURTIS 1311 HANDHELD DIAGNOSTICS GUIDE		626444		
TXT 48V CURTIS 1311 HANDHELD DIAGNOSTICS GUIDE		614450		
TXT 48V CURTIS 1313 HANDHELD DIAGNOSTICS GUIDE		627349		

MANUALS & OWNER'S GUIDES

Technical Publications : 2019 MODEL YEAR REVISED: 04 Sept 2018				
	FINAL ASSEMBLY	PARTS MANUAL	REPAIR MANUAL	OWNER'S GUIDE
	Base P/N	Manual #	Manual #	Manual #
E-Z-GO VEHICLES				
(model year begins 1 July)				
2FIVE, 2 PASSENGER 48V AC (ENGLISH) 2FIVE, 2 PASSENGER 48V AC (SPANISH)	643508	647698	647702 647702S	646299
2FIVE, 4 PASSENGER 48V AC (ENGLISH) 2FIVE, 4 PASSENGER 48V AC (SPANISH)	643509	647698	647702 647702S	646299
2 FIVE, INTL 2&4 PASS 48V AC (ENGLISH) 2FIVE, INTL 2&4 PASS 48V AC (SPANISH)	643509	647698	647702 647702S	646590
RXV FLEET 48V AC (ENGLISH) RXV FLEET 48V AC (SPANISH)	638540	647696	647700 647700S	646285
RXV FREEDOM 48V AC	638542	647696	647700	646285
RXV SHUTTLE 2+2 48V AC	638546	647696	647700	646285
RXV SHUTTLE 2+2 ELEC HIGH SPEED	638539	647696	647700	646285
RXV FLEET ELITE	654597	660325	660328	657039
RXV FREEDOM ELITE	654598	660326	660329	657040
RXV SHUTTLE 2+2 ELITE	654599	660327	660330	657041
RXV SHUTTLE 2+2 ELITE HS	654600	660327	660330	657041
RXV G FLEET (ENGLISH) RXV G FLEET (SPANISH)	638541	647697	647701 647701S	646286
RXV G FREEDOM	638543	647697	647701	646286
RXV G SHUTTLE 2+2	638545	647697	647701	646286
RXV SHUTTLE 2+2 CARB HIGH SPEED	638547	647697	647701	646286
TXT ELECTRIC FLEET (ENGLISH) TXT ELECTRIC FLEET (SPANISH)	625110	634464	634466 634466S	633137
TXT ELECTRIC FREEDOM	625112	634464	634466	633138
TXT ELECTRIC 2+2	625114	634464	634466	633139
TXT 72V FREEDOM	658071	658755	658758	658568
TXT FLEET ELITE	654601	660331	660334	657087
TXT FREEDOM ELITE	654602	660332	660335	657088
TXT SHUTTLE 2+2 ELITE	654603	660333	660336	657089
TXT GAS FLEET-TS2 (ENGLISH) TXT GAS FLEET-TS2 (SPANISH)	625111	634465	634468 634468S	633140
TXT GAS FREEDOM - TS2	625113	634465	634468	633141
TXT GAS 2+2 - TS2	625115	634465	634468	633142
TXT VALOR GAS	628444	653637	653635	628442

Technical Publications : 2019 MODEL YEAR
REVISED: 04 Sept 2018

	FINAL ASSEMBLY	PARTS MANUAL	REPAIR MANUAL	OWNER'S GUIDE
	Base P/N	Manual #	Manual #	Manual #
E-Z-GO VEHICLES				
(model year begins 1 July)				
EXPRESS S4 48V	618861	625478	625620	622014
EXPRESS S4 TS2	618862	625479	625617	622022
EXPRESS S4 HO ELEC	635082	635086	635085	635080
EXPRESS S6 E	618867	625480	625621	622013
EXPRESS S6 TS2	618868	625481	625622	622009
EXPRESS L6 E	618865	625482	625621	622013
EXPRESS L6 TS2	618866	625483	625622	622009
EXPRESS S6 72V	671113	677966		672073
EXPRESS L6 72V	671224	677968		672074
EXPRESS 4x4	682718	686459		683905
SHOP REBUILD MANUAL - STORAGE PLANNING MANUAL - HANDHELD DIAGNOSTICS GUIDES				
TUG AXLE REBUILD		641236		
KAWASAKI ENGINE REBUILD		608172		
2009 DANA AXLE REBUILD		610987		
FUJI TRANSAXLE REBUILD		628519		
FUJI AXLE REBUILD FOR KAWASAKI POWER		611374		
POWERWISE QE 36 VOLT BATTERY CHARGER		612746		
POWERWISE QE 48 VOLT BATTERY CHARGER		612747		
STORAGE PLANNING GUIDE		608259		
RXV & 2Five HANDHELD DIAGNOSTICS GUIDE		614804		
RXV & 2Five CURTIS 1313 HANDHELD DIAGNOSTICS GUIDE		627348		
RXV CURTIS 1311 HANDHELD DIAGNOSTICS GUIDE		626444		
TXT 48V CURTIS 1311 HANDHELD DIAGNOSTICS GUIDE		614450		
TXT 48V CURTIS 1313 HANDHELD DIAGNOSTICS GUIDE		627349		

MANUALS & OWNER'S GUIDES

Technical Publications : 2018 MODEL YEAR REVISED: 04 Sept 2017				
	FINAL ASSEMBLY	PARTS MANUAL	REPAIR MANUAL	OWNER'S GUIDE
	Base P/N	Manual #	Manual #	Manual #
E-Z-GO VEHICLES				
(model year begins 1 July)				
2FIVE, 2 PASSENGER 48V AC (ENGLISH) 2FIVE, 2 PASSENGER 48V AC (SPANISH)	643508	647698	647702 647702S	646299
2FIVE, 4 PASSENGER 48V AC (ENGLISH) 2FIVE, 4 PASSENGER 48V AC (SPANISH)	643509	647698	647702 647702S	646299
2 FIVE, INTL 2&4 PASS 48V AC (ENGLISH) 2FIVE, INTL 2&4 PASS 48V AC (SPANISH)	643509	647698	647702 647702S	646590
RXV FLEET 48V AC (ENGLISH) RXV FLEET 48V AC (SPANISH)	638540	647696	647700 647700S	646285
RXV FREEDOM 48V AC	638542	647696	647700	646285
RXV SHUTTLE 2+2 48V AC	638546	647696	647700	646285
RXV SHUTTLE 2+2 ELEC HIGH SPEED	638539	647696	647700	646285
RXV FLEET ELITE	654597	660325	660328	657039
RXV FREEDOM ELITE	654598	660326	660329	657040
RXV SHUTTLE 2+2 ELITE	654599	660327	660330	657041
RXV SHUTTLE 2+2 ELITE HS	654600	660327	660330	657041
RXV G FLEET (ENGLISH) RXV G FLEET (SPANISH)	638541	647697	647701 647701S	646286
RXV G FREEDOM	638543	647697	647701	646286
RXV G SHUTTLE 2+2	638545	647697	647701	646286
RXV SHUTTLE 2+2 CARB HIGH SPEED	638547	647697	647701	646286
TXT ELECTRIC FLEET (ENGLISH) TXT ELECTRIC FLEET (SPANISH)	625110	634464	634466 634466S	633137
TXT ELECTRIC FREEDOM	625112	634464	634466	633138
TXT ELECTRIC 2+2	625114	634464	634466	633139
TXT 72V FREEDOM	658071	658755	658758	658568
TXT FLEET ELITE	654601	660331	660334	657087
TXT FREEDOM ELITE	654602	660332	660335	657088
TXT SHUTTLE 2+2 ELITE	654603	660333	660336	657089
TXT GAS FLEET-TS2 (ENGLISH) TXT GAS FLEET-TS2 (SPANISH)	625111	634465	634468 634468S	633140
TXT GAS FREEDOM - TS2	625113	634465	634468	633141
TXT GAS 2+2 - TS2	625115	634465	634468	633142
TXT VALOR GAS	628444	653637	653635	628442

TECHNICAL PUBLICATIONS : 2017 MODEL YEAR (MODEL YEAR BEGINS 1 JULY) REVISED: 14 APRIL 2017

	FINAL ASSEMBLY	PARTS MANUAL	REPAIR MANUAL	OWNER'S GUIDE
	BASE P/N	MANUAL #	MANUAL #	MANUAL #
E-Z-GO VEHICLES (MODEL YEAR BEGINS 1 JULY)				
2FIVE, 2 PASSENGER 48V AC	643508	647698	647702	646299
2 FIVE, 4 PASSENGER 48V AC	643509	647698	647702	646299
2 FIVE, INTL 2&4 PASS 48V AC	643509	647698	647702	646590
RXV FLEET 48V AC (ENGLISH) RXV FLEET 48V AC (SPANISH)	638540	647696	647700 647700S	646285
RXV FREEDOM 48V AC	638542	647696	647700	646285
RXV SHUTTLE 2+2 48V AC	638546	647696	647700	646285
RXV SHUTTLE 2+2 ELEC HIGH SPEED	638539	647696	647700	646285
RXV FLEET ELITE	654597	660325	X	657039
RXV FREEDOM ELITE	654598	660326	X	657040
RXV SHUTTLE 2+2 ELITE	654599	660327	X	657041
RXV SHUTTLE 2+2 ELITE HS	654600	660327	X	657041
RXV G FLEET (ENGLISH) RXV G FLEET (SPANISH)	638541	647697	647701 647701S	646286
RXV G FREEDOM	638543	647697	647701	646286
RXV G SHUTTLE 2+2	638545	647697	647701	646286
RXV SHUTTLE 2+2 CARB HIGH SPEED	638547	647697	647701	646286
TXT ELECTRIC FLEET (ENGLISH) TXT ELECTRIC FLEET (SPANISH)	625110	634464	634466 634466S	633137
TXT ELECTRIC FREEDOM	625112	634464	634466	633138
TXT ELECTRIC 2+2	625114	634464	634466	633139
TXT 5 PASSENGER ELEC	600924	620272	600938	607729
TXT 72V FREEDOM	658071	658755	X	658568
TXT FLEET ELITE	654601	660331	X	657087
TXT FREEDOM ELITE	654602	660332	X	657088
TXT SHUTTLE 2+2 ELITE	654603	660333	X	657089
TXT GAS FLEET-TS2 (ENGLISH) TXT GAS FLEET-TS2 (SPANISH)	625111	634465	634468 634468S	633140
TXT GAS FREEDOM - TS2	625113	634465	634468	633141
TXT GAS 2+2 - TS2	625115	634465	634468	633142
TXT VALOR GAS	628444	653637	653635	628442
TERRAIN 250 48V	618854	625474	625616	622018
TERRAIN 250 TS2	618855	625475	625617	622012
TERRAIN 1000 72V	638709	640756	640757	639050
TERRAIN 1000 TS2	618859	625475	625617	622022
EXPRESS S4 48V	618861	625478	625620	622014
EXPRESS S4 TS2	618862	625479	625617	622022
EXPRESS S4 HO ELEC	635082	635086	635085	635080
EXPRESS S6 E	618867	625480	625621	622013
EXPRESS S6 TS2	618868	625481	625622	622009
EXPRESS L6 E	618865	625482	625621	622013
EXPRESS L6 TS2	618866	625483	625622	622009

MANUALS & OWNER'S GUIDES

Technical Publications : 2015-2016 MODEL YEAR				
VEHICLE MODEL		PARTS MANUAL	SERVICE MANUAL	OWNER'S GUIDE
Model #	Base P/N	Manual #	Manual #	Manual #
E-Z-GO BRANDED VEHICLES				
2Five, 2 passenger (LSV) 48V AC	606760	631369	609432	610598
2 Five, 4 passenger (LSV) 48V AC	606761	631369	609432	610598
RXV Fleet 48V AC	606600	631368	611105	610992
RXV Freedom 48V AC	606602	631368	611105	610992
RXV Shuttle 2+2 48V AC	606604	631368	611105	610992
RXV G Fleet	614418	631225	611106	615262
RXV G Freedom	614419	631225	611106	615262
RXV G Shuttle 2+2	614420	631225	611106	615262
RXV Shuttle 2+2 CARB HIGH SPEED	615270	631225	611106	615262
RXV Shuttle 2+2 ELEC HIGH SPEED	609184	631368	611105	610992
TXT ELECTRIC FLEET	625110	631719	634464	633137
TXT ELECTRIC FREEDOM	625112	631719	634464	633138
TXT ELECTRIC 2+2	625114	631719	634464	633139
TXT GAS FLEET-TS2	625111	631720	634465	633140
TXT GAS FREEDOM - TS2	625113	631720	634465	633141
TXT GAS 2+2 - TS2	625115	631720	634465	633142
TXT VALOR GAS	628444	631720	614275	628442
TERRAIN 250 48V	618854	631372	625474	622018
TERRAIN 250 TS2	618855	631374	625475	622012
TERRAIN 1000 48V	618858	631373	625476	623528
TERRAIN 1000 72V	638709	634749	640756	639050
TERRAIN 1000 TS2	618859	631375	625475	622022
TERRAIN 1500 TS2	618860	631375	625477	622021
EXPRESS S4 48V	618861	631379	625478	622014
EXPRESS S4 TS2	618862	631380	625479	622022
EXPRESS S4 HO ELEC	635082	635189	635086	635080
EXPRESS L4 48V	618863	631379	625478	622014
EXPRESS L4 TS2	618864	631380	625479	622022
EXPRESS S6 E	618867	631395	625480	622013
EXPRESS S6 TS2	618868	631396	625481	622009
EXPRESS L6 E	618865	631395	625482	622013
EXPRESS L6 TS2	618866	631396	625483	622009

VEHICLE MODEL		PARTS MANUAL	SERVICE MANUAL	OWNER'S GUIDE
Model #	Base P/N	Manual #	Manual #	Manual #
E-Z-GO BRANDED VEHICLES				
2FIVE, 2 PASSENGER (LSV) 48V AC	606760	609432	606779	610598
2 FIVE, 4 PASSENGER (LSV) 48V AC	606761	609432	606779	610598
2FIVE 2 PASSENGER EXCEED	618513	609432 & 626119	-----	610598 & 618966
2FIVE 4 PASSENGER EXCEED	618514	609432 & 626119	-----	610598 & 618966
RXV SHUTTLE 2+2 HIGH SPEED EXCEED	618518	611105 & 626119	-----	610992 & 618966
RXV SHUTTLE 2+2 EXCEED	618512	611105 & 626119	-----	610992 & 618966
RXV FREEDOM EXCEED	618511	611105 & 626119	-----	610992 & 618966
RXV FLEET 48V AC	606600	611105	611103	610992
RXV FREEDOM 48V AC	606602	611105	611103	610992
RXV SHUTTLE 2+2 48V AC	606604	611105	611103	610992
RXV G FLEET	614418	611106	611104	615262
RXV G FREEDOM	614419	611106	611104	615262
RXV G SHUTTLE 2+2	614420	611106	611104	615262
RXV SHUTTLE 2+2 CARB HIGH SPEED	615270	611106	611104	615262
RXV SHUTTLE 2+2 ELEC HIGH SPEED	609184	611105	611103	610992
TXT ELECTRIC FLEET	625110	634464	634466	633137
TXT ELECTRIC FREEDOM	625112	634464	634466	633138
TXT ELECTRIC 2+2	625114	634464	634466	633139
TXT GAS FLEET-TS2	625111	634465	634468	633140
TXT GAS FREEDOM - TS2	625113	634465	634468	633141
TXT GAS 2+2 - TS2	625115	634465	634468	633142
TXT VALOR GAS	628444	614275	614276	628442
TERRAIN 250 48V	618854	625474	625616	622018
TERRAIN 250 TS2	618855	625475	625617	622012
TERRAIN 1000 48V	618858	625476	625618	623528
TERRAIN 1000 TS2	618859	625475	625617	622022
TERRAIN 1500 TS2	618860	625477	625619	622021
EXPRESS S4 48V	618861	625478	625620	622014
EXPRESS S4 TS2	618862	625479	625617	622022
EXPRESS S4 HO ELEC	635082	Pending	Pending	635080
EXPRESS L4 48V	618863	625478	625620	622014
EXPRESS L4 TS2	618864	625479	625617	622022
EXPRESS S6 E	618867	625480	625621	622013
EXPRESS S6 TS2	618868	625481	625622	622009
EXPRESS L6 E	618865	625482	625621	622013
EXPRESS L6 TS2	618866	625483	625622	622009

MANUALS & OWNER'S GUIDES

Technical Publications : 2013 MODEL YEAR		REVISED: 24 OCTOBER 2012		
VEHICLE MODEL		PARTS MANUAL	SERVICE MANUAL	OWNER'S GUIDE
Model #	Base P/N	Manual #	Manual #	Manual #
E-Z-GO BRANDED VEHICLES				
2Five, 2 passenger (LSV) 48V AC	606760	609432	606779	610598
2 Five, 4 passenger (LSV) 48V AC	606761	609432	606779	610598
2Five 2 passenger EXCEED	618513	609432 & 626119		610598 & 618966
2Five 4 passenger EXCEED	618514	609432 & 626119		610598 & 618966
RXV Shuttle 2+2 High Speed EXCEED	618518	611105 & 626119		610992 & 618966
RXV Shuttle 2+2 EXCEED	618512	611105 & 626119		610992 & 618966
RXV Freedom EXCEED	618511	611105 & 626119		610992 & 618966
RXV Fleet 48V AC	606600	611105	611103	610992
RXV Freedom 48V AC	606602	611105	611103	610992
RXV Shuttle 2+2 48V AC	606604	611105	611103	610992
RXV G Fleet	614418	611106	611104	615262
RXV G Freedom	614419	611106	611104	615262
RXV G Shuttle 2+2	614420	611106	611104	615262
RXV Shuttle 2+2 CARB HIGH SPEED	615270	611106	611104	615262
RXV Shuttle 2+2 ELEC HIGH SPEED	609184	611105	611103	610992
TXT 48V FLEET	612623	614278	614279	613272
TXT 48V FREEDOM	614265	614278	614279	614277
TXT 48V 2+2	614372	614278	614279	614277
TXT GAS FREEDOM-TS2	612946	614275	614276	612949
TXT GAS FLEET - TS2	614374	614275	614276	614212
TXT GAS 2+2 - TS2	614439	614275	614276	612949
TXT VALOR GAS	628444	614275	614276	628442
TERRAIN 250 48V	618854	625474	625616	622018
TERRAIN 250 TS2	618855	625475	625617	622012
TERRAIN 500 TS2	618856	625475	625617	622022
TERRAIN 1000 48V	618858	625476	625618	623528
TERRAIN 1000 TS2	618859	625475	625617	622022
TERRAIN 1500 TS2	618860	625477	625619	622021
EXPRESS S4 48V	618861	625478	625620	622014
EXPRESS S4 TS2	618862	625479	625617	622022
EXPRESS L4 48V	618863	625478	625620	622014
EXPRESS L4 TS2	618864	625479	625617	622022
EXPRESS S6 E	618867	625480	625621	622013
EXPRESS S6 TS2	618868	625481	625622	622009

VEHICLE MODEL				
Model #	Base P/N	Manual #	Manual #	Manual #
E-Z-GO BRANDED VEHICLES				
2Five, 2 passenger (LSV) 48V AC	606760	609432	606779	610598
2 Five, 4 passenger (LSV) 48V AC	606761	609432	606779	610598
2Five 2 passenger EXCEED	618513			610598 & 618966
2Five 4 passenger EXCEED	618514			610598 & 618966
RXV Shuttle 2+2 High Speed EXCEED	618518			610992 & 618966
RXV Shuttle 2+2 EXCEED	618512			610992 & 618966
RXV Freedom EXCEED	618511			610992 & 618966
RXV Fleet 48V AC	606600	611105	611103	610992
RXV Freedom 48V AC	606602	611105	611103	610992
RXV Shuttle 2+2 48V AC	606604	611105	611103	610992
RXV G Fleet	614418	611106	611104	615262
RXV G Freedom	614419	611106	611104	615262
RXV G Shuttle 2+2	614420	611106	611104	615262
RXV Shuttle 2+2 CARB HIGH SPEED	615270	611106	611104	615262
RXV Shuttle 2+2 ELEC HIGH SPEED	609184	611105	611103	610992
TXT 48V FLEET	612623	614278	614279	613272
TXT 48V FREEDOM	614265	614278	614279	614277
TXT 48V 2+2	614372	614278	614279	614277
TXT GAS FREEDOM-TS2	612946	614275	614276	612949
TXT GAS FLEET - TS2	614374	614275	614276	614212
TXT GAS 2+2 - TS2	614439			
SHUTTLE 2 ELE/FRT BRK	600071	601029	600938	605693
SHUTTLE 4/6 48 V PDS	600918	601029	600938	605693
SHUTTLE 2 GAS - TS2	606690	620388	620374	607362
SHUTTLE 4/6-GAS - TS2	606679	620388	620374	607362
TERRAIN 250 48V	618854	625474		622018
TERRAIN 250 TS2	618855	625475		622012
TERRAIN 500 TS2	618856	625475		622022
TERRAIN 1000 48V	618858	625476		623528
TERRAIN 1000 TS2	618859	625475		622022
TERRAIN 1500 TS2	618860	625477		622021
EXPRESS S4 48V	618861	625478		622014
EXPRESS S4 TS2	618862	625479		622022
EXPRESS L4 48V	618863	625478		622014
EXPRESS L4 TS2	618864	625479		622022
EXPRESS S6 E	618867	625480		622013
EXPRESS S6 TS2	618868	625481		622009
EXPRESS L6 E	618865	625482		622013
EXPRESS L6 TS2	618866	625483		622009

TXT 1996- CURRENT





TXT TABLE OF CONTENTS

Accelerator	16-17
Battery & Charger	18-25
Body & Trim	26-37
Clutches	38-40
Direction Selector	41-43
Electric Motor	44-46
Electrical System	47-53
Engine	54-62
Front Suspension & Steering	63-70
Fuel System	71-73
On the Course	74-75
Rear Axle	76-79
Rear Suspension	80-84
Seating	85-90
Specialty Tools	91-92
Tops, Windshields & Protection	93-95



ACCELERATOR

SUB SECTION	PAGE
SWITCHES	17

SWITCHES



25854G01 INDUCTIVE THROTTLE SENSOR
1996+ TXT



25861G01 PEDALBOX MICROSWITCH
1996+ TXT; 2017+ 72V TXT

ACCELERATOR

AIR CLEANER

BATTERY & CHARGER

BODY & TRIM

CLUTCHES

DIRECTION SELECTOR

ELECTRIC MOTOR

ELECTRICAL SYSTEM

ENGINE & MUFFLER

FRONT SUSPENSION & STEERING

FUEL SYSTEM

ON THE COURSE

REAR AXLE

REAR SUSPENSION

SEATING

SPECIALTY TOOLS

TOPS, WINDSHIELDS & PROTECTION



BATTERY & CHARGERS

SUB SECTION	PAGE
BATTERY WATERING SYSTEM & COMPONENTS	19
CABLES & WIRING	19-21
CORDS	21-22
CHARGERS	22
CONTROL BOARDS & TIMERS	22
DISCHARGERS	23
FUSES, DIODES & RELAYS	23
HOLD DOWNS & STRAPS	23
LITHIUM	24-25

BATTERY WATERING SYSTEM & COMPONENTS



676122 TROJAN HAND PUMP
UNIVERSAL

CABLES & WIRING



613236 6AWG 380MM BLUE WIRE ASSEMBLY
2014+ TXT



613237 6AWG 150MM BLUE WIRE ASSEMBLY
2010+ TXT

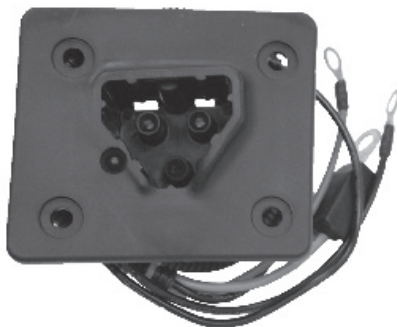

PART NUMBER	DESCRIPTION	VEHICLE
613304	48V CHARGER RECEPTACLE	2014+ TXT
663285	CHARGING RECEPTACLE	2017+ 72V TXT

ACCELERATOR

AIR CLEANER

**BATTERY
& CHARGER**

BODY & TRIM

CLUTCHES

DIRECTION
SELECTOR

ELECTRIC
MOTOR

ELECTRICAL
SYSTEM

ENGINE
& MUFFLER

FRONT
SUSPENSION
& STEERING

FUEL SYSTEM

ON THE
COURSE

REAR AXLE

REAR
SUSPENSION

SEATING

SPECIALTY
TOOLS

TOPS,
WINDSHIELDS
& PROTECTION

BATTERY & CHARGER



607590 4AWG 7IN GREEN WIRE ASSEMBLY
2005-2011 TXT



607591 4AWG 11.5IN GREEN WIRE ASSEMBLY
2005-2011 TXT



25972G32 6GA BLACK WIRE ASSEMBLY
1996-2004 TXT



25972G40 6GA WIRE ASSEMBLY
1996-2004 TXT



73051G05 POWERWISE RECEPTACLE
1997-2011 TXT

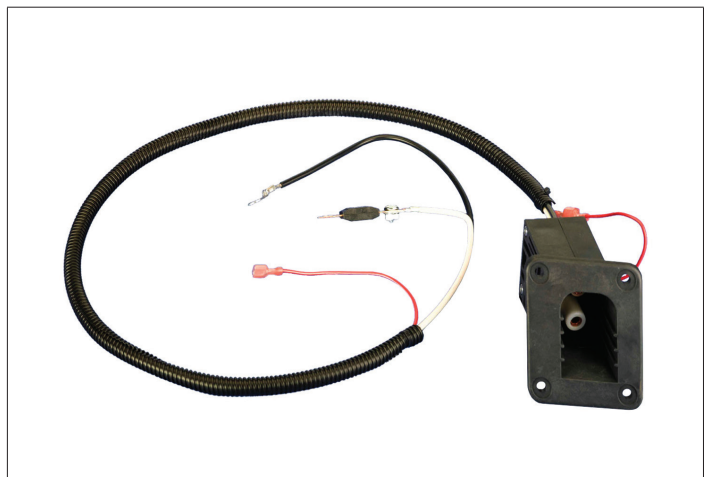

73063G01 36V CHARGER RECEPTACLE W/ HARNESS
1996-2011 TXT



73149G01 36V POWERWISE RECEPTACLE W/ HARNESS
1996-2002 TXT



750332PKG 48V TXT BATTERY WIRING PACKAGE
2014+ TXT



750345PKG 4 GA GREEN WIRE PACKAGE
1996-2013 TXT

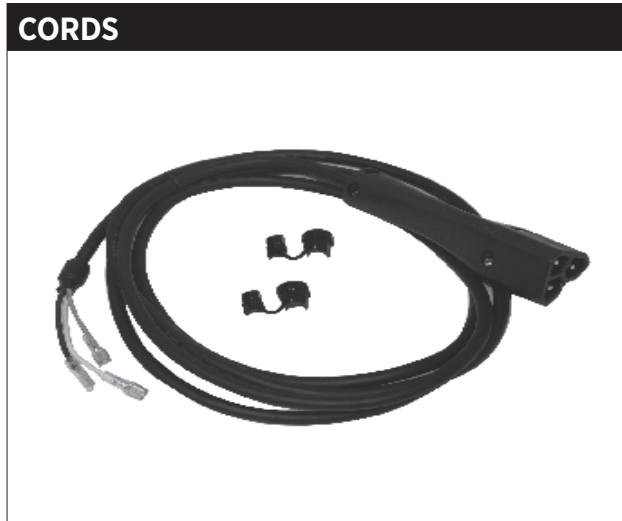

611218 48V 3M CORD KIT
UNIVERSAL



611219 48V 5.5M CORD KIT
UNIVERSAL



618638 48V DC CORD PLUG KIT
UNIVERSAL

ACCELERATOR

AIR CLEANER

**BATTERY
& CHARGER**

BODY & TRIM

CLUTCHES

DIRECTION
SELECTOR

ELECTRIC
MOTOR

ELECTRICAL
SYSTEM

ENGINE
& MUFFLER

FRONT
SUSPENSION
& STEERING

FUEL SYSTEM

ON THE
COURSE

REAR AXLE

REAR
SUSPENSION

SEATING

SPECIALTY
TOOLS

TOPS,
WINDSHIELDS
& PROTECTION

BATTERY & CHARGER



73051G02 POWERWISE CHARGING PLUG
UNIVERSAL

CHARGERS



622419 48V WORLD CHARGER W/ 3M CORD
2014+ TXT



635671 48V CHARGER W/ 3M CORD
2014+ TXT



653213 LITHIUM CHARGER W/ 3M CORD
2017+ TXT ELITE



653214 LITHIUM CHARGER W/ 3M CORD
2017+ TXT ELITE

CONTROL BOARDS & TIMERS

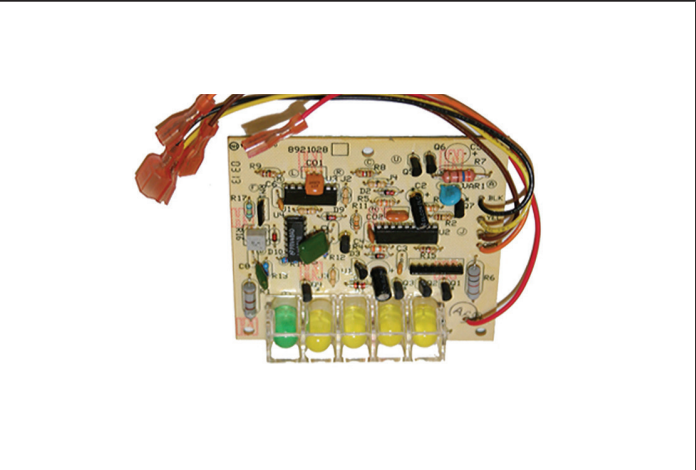

28667G01 POWERWISE POWER INPUT CONTROL BOARD
1996-2011 TXT

DISCHARGERS



631968 72V BATTERY DISCHARGER
UNIVERSAL

FUSES, DIODES & RELAYS



28109G01 20MFD/330VAC POWERWISE CAPACITOR
1996-2011 TXT

HOLD DOWNS & STRAPS



652254G03 BATTERY RACK
2014+ TXT

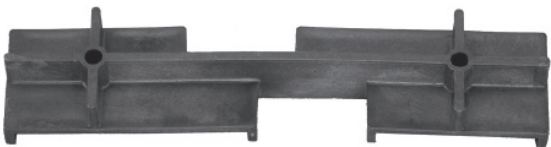

612867 BATTERY RETAINER
UNIVERSAL



606312 BATTERY TERMINAL PROTECTOR SPRAY
UNIVERSAL

ACCELERATOR

AIR CLEANER

**BATTERY
& CHARGER**

BODY & TRIM

CLUTCHES

DIRECTION
SELECTOR

ELECTRIC
MOTOR

ELECTRICAL
SYSTEM

ENGINE
& MUFFLER

FRONT
SUSPENSION
& STEERING

FUEL SYSTEM

ON THE
COURSE

REAR AXLE

REAR
SUSPENSION

SEATING

SPECIALTY
TOOLS

TOPS,
WINDSHIELDS
& PROTECTION

LITHIUM



696855 BATTERY MANAGEMENT SYSTEM
2017+ TXT ELITE



665954 30AH CELL MODULE
2017+ TXT ELITE



BODY & TRIM

SUB SECTION	PAGE
ACCESS PANEL	27
BAGWELL LINER	27
BODY & COWLS	28
BUMPERS & BRUSHGUARDS	29-30
FENDER FLARES & MUD GUARDS	30-31
FLOOR MATS	32
FRAMES	32
FRONT SHIELDS	33-34
INSTRUMENT PANEL	34-35
KICK PLATE	35
ROCKER PANELS & SILL PLATES	36-37
SCUFF GUARDS	37
RESTORATION	37
SPRAY PAINT	37

ACCESS PANEL

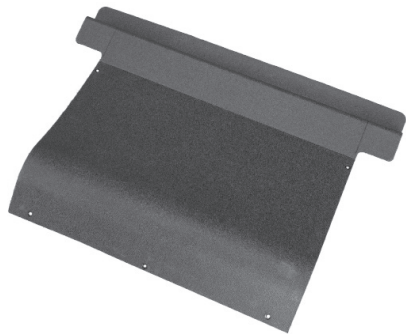

71320G01 BLACK ACCESS COVER
1996-2013 TXT

BAGWELL LINER



624374 BAGWELL LINER
2014+ TXT; 2017+ TXT ELITE

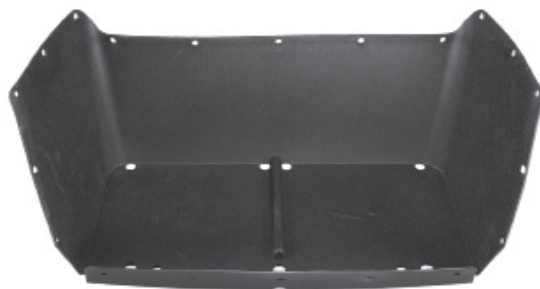

71318G01 BAGWELL LINER
1996-2013 TXT

ACCELERATOR

AIR CLEANER

BATTERY &
CHARGER

BODY & TRIM

CLUTCHES

DIRECTION
SELECTOR

ELECTRIC
MOTOR

ELECTRICAL
SYSTEM

ENGINE
& MUFFLER

FRONT
SUSPENSION
& STEERING

FUEL SYSTEM

ON THE
COURSE

REAR AXLE

REAR
SUSPENSION

SEATING

SPECIALTY
TOOLS

TOPS,
WINDSHIELDS
& PROTECTION

TXT BODY & COWL

2014-CURRENT WITHOUT LIGHT CUT-OUTS

COWL

SUNBURST ORANGE	619730G051
STEEL BLUE	619730G026
ALMOND	619730G044
HUNTER GREEN	619730G037
PLATINUM	619730G042
SAFETY YELLOW	619730G035
PATRIOT BLUE	619730G019
BRIGHT WHITE	619730G038
BURGUNDY	619730G043
JAVA BROWN	619730G076
INFERNO RED	619730G020
ELECTRIC BLUE	619730G041
MONSTER GREEN	619730G069
METALLIC CHARCOAL	619730G031
OCEAN GRAY	619730G0A5

BODY

SUNBURST ORANGE	625272G051
STEEL BLUE	625272G026
ALMOND	625272G044
HUNTER GREEN	625272G037
PLATINUM	625272G042
SAFETY YELLOW	625272G035
PATRIOT BLUE	625272G019
BRIGHT WHITE	625272G038
BURGUNDY	625272G043
JAVA BROWN	625272G076
INFERNO RED	625272G020
ELECTRIC BLUE	625272G041
MONSTER GREEN	625272G069
METALLIC CHARCOAL	625272G031
OCEAN GRAY	625272G0A5



BUMPERS & BRUSHGUARDS



617620 BRUSHGUARD
2017+ 72V TXT



71451G02 REAR BUMPER
2014+ TXT; 2017+ 72V TXT



71456G01 REAR BUMPER
1996-2013 TXT



628532 BLACK BRUSH GUARD
1996-2013 TXT



634329 BUMPER ASSEMBLY
2014+ TXT; 2017+ TXT ELITE

ACCELERATOR

AIR CLEANER

BATTERY &
CHARGER

BODY & TRIM

CLUTCHES

DIRECTION
SELECTOR

ELECTRIC
MOTOR

ELECTRICAL
SYSTEM

ENGINE
& MUFFLER

FRONT
SUSPENSION
& STEERING

FUEL SYSTEM

ON THE
COURSE

REAR AXLE

REAR
SUSPENSION

SEATING

SPECIALTY
TOOLS

TOPS,
WINDSHIELDS
& PROTECTION

BODY & TRIM



695282 REAR BUMPER
1996-2013 TXT

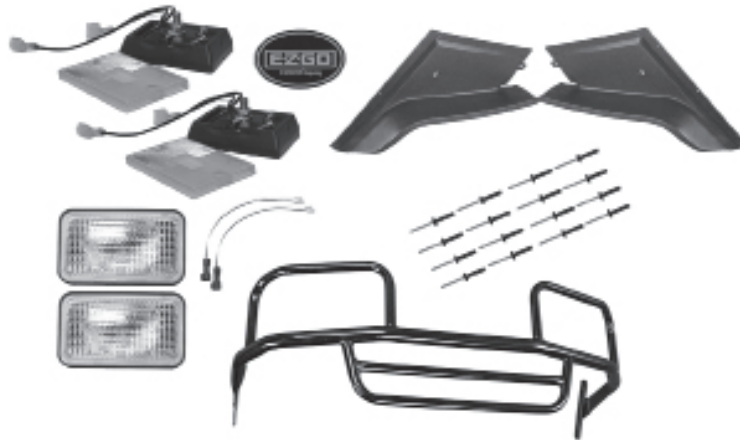

750286PKG BLACK BRUSH GUARD PACKAGE
1996-2013 TXT

FENDER FLARES & MUD GUARDS



613274 PASSENGERS SIDE FENDER FLARE
2018+ 72V TXT

614378 DRIVERS SIDE FRONT FENDER FLARE
2018+ 72V TXT



635054G01 DRIVERS SIDE FENDER LINER
2014+ TXT; 2017+ TXT ELITE

635054G02 PASSENGERS SIDE FENDER LINER
2014+ TXT; 2017+ TXT ELITE



656538 FRONT SPLASH GUARD KIT
2014+ TXT

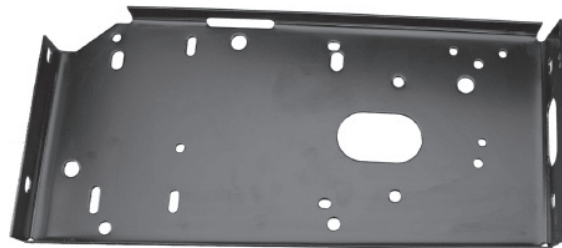

70244G05 PAINTED SPLASH PAN
2014+ TXT; 2017+ TXT ELITE



750174PKG TXT MUD GUARD PACKAGE
1996-2013 TXT

ACCELERATOR

AIR CLEANER

BATTERY &
CHARGER

BODY & TRIM

CLUTCHES

DIRECTION
SELECTOR

ELECTRIC
MOTOR

ELECTRICAL
SYSTEM

ENGINE
& MUFFLER

FRONT
SUSPENSION
& STEERING

FUEL SYSTEM

ON THE
COURSE

REAR AXLE

REAR
SUSPENSION

SEATING

SPECIALTY
TOOLS

TOPS,
WINDSHIELDS
& PROTECTION

FLOORMATS

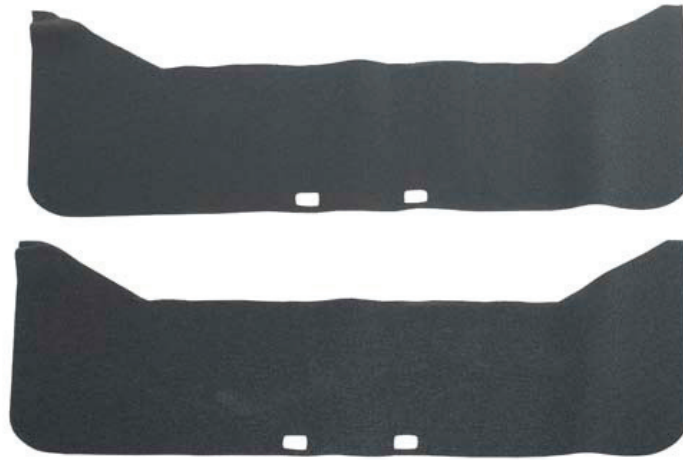

PART NUMBER	DESCRIPTION	VEHICLE
637535G02	FLOOR MAT WITH HORN HOLE	2014+ TXT; 2017+ TXT ELITE
70362G01	RUBBER FOOTREST MAT	1996+ TXT
70663G04	FLOOR MAT WITH HORN HOLE	2017+ 72V TXT
70663G07	FLOOR MAT	2017+ 72V TXT
70451G01	LOWER FLOORBOARD	1996+ TXT; 2017+ TXT ELITE; 2017+ 72V TXT
70663G03	FLOOR MAT	2017+ 72V TXT
70663G06	FLOOR MAT WITH HORN HOLE	2017+ 72V TXT

FRAMES



72011G01 REAR ENGINE FRAME
1996-2008 TXT

FRONT SHIELDS



613273 FRONT FASCIA
2018+ 72V TXT



617643 COWL GRILL COVER
2017+ 72V TXT



70725G02 FRONT SHIELD BRACE
2001+ TXT; 2017+ TXT ELITE; 2017+ 72V TXT



618653 FRONT FASCIA BRACKET
2017+ 72V TXT



624607 FRONT FASCIA
627769 FASCIA BRACKET
2014+ TXT; 2017+ TXT ELITE

ACCELERATOR

AIR CLEANER

BATTERY &
CHARGER

BODY & TRIM

CLUTCHES

DIRECTION
SELECTOR

ELECTRIC
MOTOR

ELECTRICAL
SYSTEM

ENGINE
& MUFFLER

FRONT
SUSPENSION
& STEERING

FUEL SYSTEM

ON THE
COURSE

REAR AXLE

REAR
SUSPENSION

SEATING

SPECIALTY
TOOLS

TOPS,
WINDSHIELDS
& PROTECTION

BODY & TRIM



27166G04 FRONT SHIELD
1996-2013 TXT



750520PKG 2014+ TXT FRONT SHIELD PACKAGE
2014+ TXT

INSTRUMENT PANEL



71151G03 INSTRUMENT PANEL ASSEMBLY
1996-2013 TXT



71151G01 INSTRUMENT PANEL ASSEMBLY
1996-2013 TXT



628023 CUP HOLDER
2014+ TXT; 2017+ TXT ELITE



71158G01 4 CUP INSTRUMENT PANEL INSERT
1996+ TXT; 2017+ 72V TXT



601016 CONSOLE INSERT PLATE WITH KEY/FORWARD-REVERSE
2010-2013 TXT

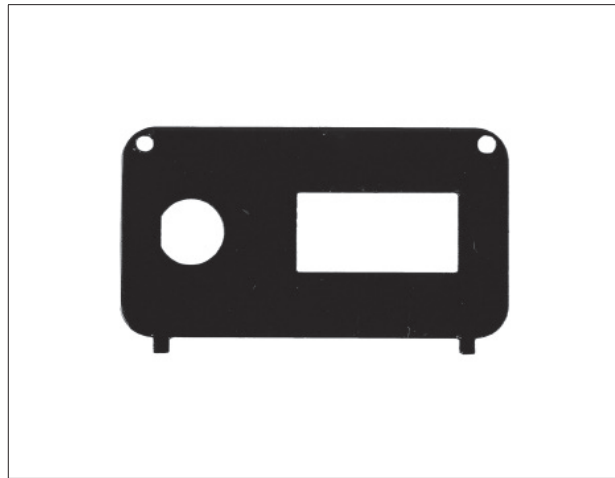

73030G02 CONSOLE PLATE WITH KEY/STATE OF CHARGE
1996-2013 TXT

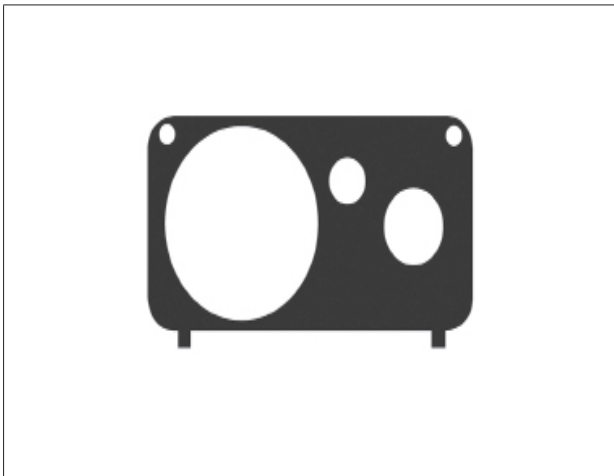

73030G04 CONSOLE INSERT PLATE WITH KEY/FUEL GAUGE/OIL LIGHT
1996-2013 TXT

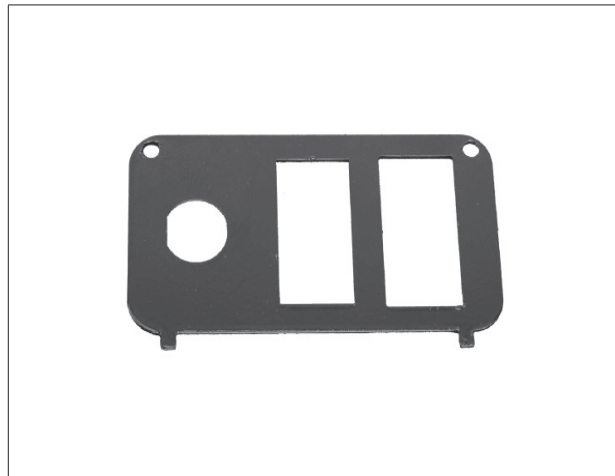

73030G06 CONSOLE INSERT PLATE
1996-2013 TXT



641632G02 PASSENGERS SIDE BALL HOLDER
2014+ TXT; 2017+ TXT ELITE; 2018+ 72V TXT



605394 BLACK KICK PLATE
2001+ TXT

ACCELERATOR

AIR CLEANER

BATTERY & CHARGER

BODY & TRIM

CLUTCHES

DIRECTION SELECTOR

ELECTRIC MOTOR

ELECTRICAL SYSTEM

ENGINE & MUFFLER

FRONT SUSPENSION & STEERING

FUEL SYSTEM

ON THE COURSE

REAR AXLE

REAR SUSPENSION

SEATING

SPECIALTY TOOLS

TOPS, WINDSHIELDS & PROTECTION

ROCKER PANELS & SILL PLATES



PART NUMBER	DESCRIPTION	VEHICLE
615239	DRIVERS SIDE ROCKER PANEL	2010+ TXT; 2017+ TXT ELITE
617333	PASSENGERS SIDE ROCKER PANEL	
71502G01	DRIVERS SIDE ROCKER PANEL	1996-2013 TXT
71501G01	PASSENGERS SIDE ROCKER PANEL	
639948G01	DRIVERS SIDE ROCKER PANEL	2017+ 72V TXT
639948G02	PASSENGERS SIDE ROCKER PANEL	



750168PKG DIAMOND PANEL ROCKER PANEL PACKAGE
1996-2013 TXT



750169PKG BLACK DIAMOND PLATE ROCKER PANEL PACKAGE
1996-2013 TXT



750594PKG 2014+ TXT BLACK ROCKER COVER PACKAGE
2014+ TXT



625211 PASSENGERS SIDE SCUFF PAD
2014+ TXT; 2017+ TXT ELITE; 72V TXT
625210 DRIVERS SIDE SCUFF PAD
2014+ TXT; 2017+ TXT ELITE; 72V TXT

RESTORATION



750183PKG CLEANING AND RESTORATION TRIO
UNIVERSAL

SPRAY PAINT



PART NUMBER	DESCRIPTION	VEHICLE
27758G01	BLACK	UNIVERSAL
28140G14	FLEET YELLOW	
28140G09	HUNTER GREEN	
28140G15	CHAMPAGNE BEIGE	

ACCELERATOR

AIR CLEANER

BATTERY & CHARGER

BODY & TRIM

CLUTCHES

DIRECTION SELECTOR

ELECTRIC MOTOR

ELECTRICAL SYSTEM

ENGINE & MUFFLER

FRONT SUSPENSION & STEERING

FUEL SYSTEM

ON THE COURSE

REAR AXLE

REAR SUSPENSION

SEATING

SPECIALTY TOOLS

TOPS, WINDSHIELDS & PROTECTION



CLUTCHES

SUB SECTION	PAGE
BELTS	39
DRIVE CLUTCHES	39
DRIVEN CLUTCHES	40
PACKAGES	40

BELTS



606138 STARTER BELT
2010+ TXT



618630 TEAM DRIVE BELT
2010+ TXT



72328G01 SEVERE DUTY CVT DRIVE BELT
2001-2009 TXT

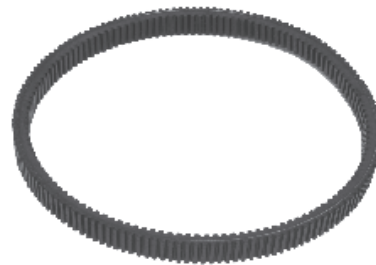

606136 DRIVE BELT
2010+ TXT

DRIVE CLUTCHES



672686 TEAM PRIMARY CLUTCH
2014+ TXT



26952G01 DRIVE CLUTCH
1996-2009 TXT

ACCELERATOR

AIR CLEANER

BATTERY &
CHARGER

BODY & TRIM

CLUTCHES

DIRECTION
SELECTOR

ELECTRIC
MOTOR

ELECTRICAL
SYSTEM

ENGINE

FRONT
SUSPENSION
& STEERING

FUEL SYSTEM

ON THE
COURSE

REAR AXLE

REAR
SUSPENSION

SEATING

SPECIALTY
TOOLS

TOPS,
WINDSHIELDS
& PROTECTION

CLUTCHES

DRIVEN CLUTCHES



623949 TEAM SECONDARY CLUTCH
2010+ TXT

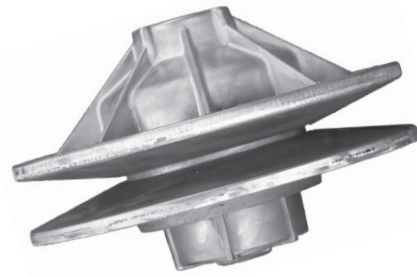

26301G02 DRIVEN CLUTCH
1996-2009 TXT



26301G03 DRIVEN CLUTCH
1996-2009 TXT

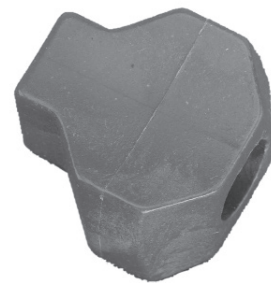

26479G01 DRIVEN CLUTCH RAMP BUTTON
1996-2009 TXT

PACKAGES



750410PKG KAWASAKI CLUTCH UPGRADE PACKAGE
2010+ TXT



DIRECTION SELECTOR

SUB SECTION	PAGE
CABLES & LINKAGE	42
DIRECTION SELECTOR ASSEMBLY	42
SWITCHES	42-43

DIRECTION SELECTOR

CABLES & LINKAGE



603615 SHORT WHEEL BASE FNR CABLE
2010+ TXT



71205G01 FNR HANDLE
1996+ TXT



73049G01 FNR COVER
1996+ TXT; 2017+ TXT ELITE



602891 FNR PUSH/PULL CABLE
2007-2009 TXT

DIRECTION SELECTOR ASSEMBLY



25691G01 SHIFT CONTROL CABLE
1996-2002 TXT

SWITCHES



74323G01 FNR SWITCH
2000-2013 TXT



14651G1 FNR CONTACT BOARD ASSEMBLY
1996-2013 TXT

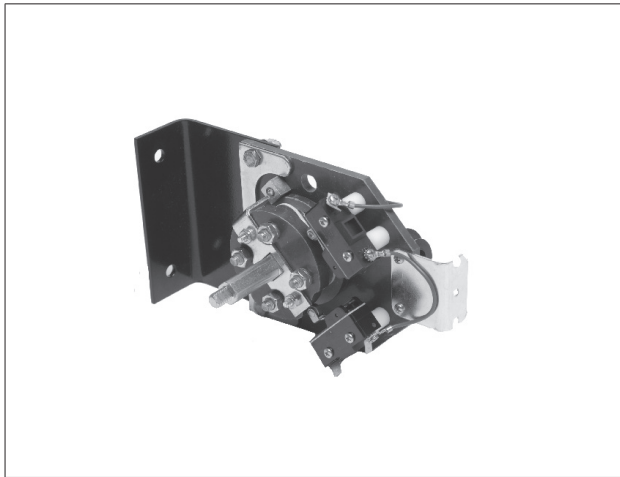

70578G02 FNR SWITCH ASSEMBLY
1998-2013 TXT

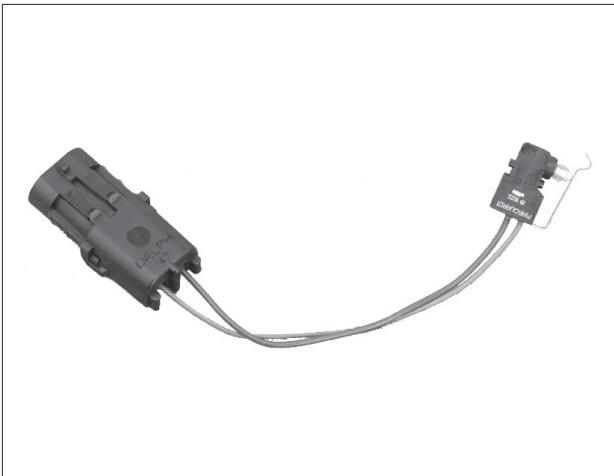

73195G01 DCS FNR SWITCH ASSEMBLY
1996-2002 TXT

ACCELERATOR

AIR CLEANER

BATTERY &
CHARGER

BODY & TRIM

CLUTCHES

**DIRECTION
SELECTOR**

ELECTRIC
MOTOR

ELECTRICAL
SYSTEM

ENGINE
& MUFFLER

FRONT
SUSPENSION
& STEERING

FUEL SYSTEM

ON THE
COURSE

REAR AXLE

REAR
SUSPENSION

SEATING

SPECIALTY
TOOLS

TOPS,
WINDSHIELDS
& PROTECTION



ELECTRIC MOTOR

SUB SECTION
MOTORS & COMPONENTS

PAGE
45-46

MOTORS & COMPONENTS



614252 RXV SPEED SENSOR KIT
2017+ 72V TXT



750440PKG 48V SE MOTOR PACKAGE
2014+ TXT



624105 48V SC MOTOR
2014+ TXT; 2017+ TXT ELITE

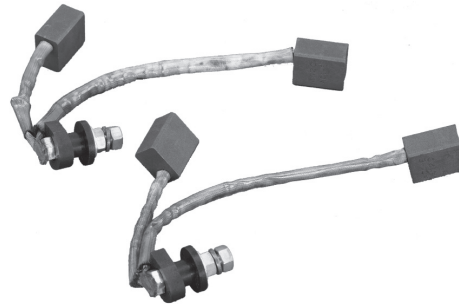

73120G25 BRUSH REPLACEMENT KIT
2000+ TXT; 2017+ TXT ELITE



73328G01 PDS SPEED SENSOR MAGNET
2000+ TXT; 2017+ TXT ELITE



73124G01 36V DCS FLEET MOTOR
1996-1999 TXT

ACCELERATOR

AIR CLEANER

BATTERY &
CHARGER

BODY & TRIM

CLUTCHES

DIRECTION
SELECTOR

**ELECTRIC
MOTOR**

ELECTRICAL
SYSTEM

ENGINE
& MUFFLER

FRONT
SUSPENSION
& STEERING

FUEL SYSTEM

ON THE
COURSE

REAR AXLE

REAR
SUSPENSION

SEATING

SPECIALTY
TOOLS

TOPS,
WINDSHIELDS
& PROTECTION

ELECTRIC MOTOR



73124G03 ELECTRIC HS SERIES MOTOR
2000-2011 TXT



73327G01 PDS SPEED SENSOR
2000-2011 TXT



73445G01 ADC FLEET SPEED MOTOR
1996-2013 TXT



ELECTRICAL SYSTEM

SUB SECTION	PAGE
CHARGERS	48
GAUGES	48
HARNESSES	48-49
IGNITION SWITCHES	49-50
LIGHTS	50
SOLENOIDS	51
SPEED CONTROLLER	51
SPEED CONTROLLER COMPONENTS	52
SWITCHES	53
TURN SIGNALS	53
VOLTAGE REGULATOR	53

ELECTRICAL SYSTEM

CHARGERS



73051G28 ENCAPSULATED REED SWITCH ASSEMBLY
2002-2004 TXT

GAUGES



617074 HOUR METER
2010+ TXT



21553G1 FUEL GAUGE
1996+ TXT



33636G05 48V VERTICAL STATE OF CHARGE METER
2014+ TXT



750288PKG 48V VERTICAL STATE OF CHARGE METER
PACKAGE
2014+ TXT

HARNESSES



620418 48V PEDAL/ITS HARNESS
2010+ TXT

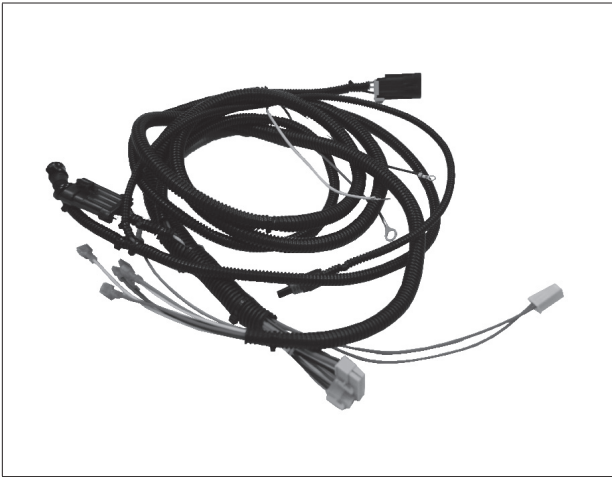

620196 48V MAIN WIRE HARNESS
2010-2013 TXT



74324G02 DCS CONTROL WIRE HARNESS
2005-2011 TXT

IGNITION SWITCHES



611282 COMMON KEY SET ASSEMBLY
2017+ TXT ELITE



18602G1 IGNITION SWITCH
1996+ TXT

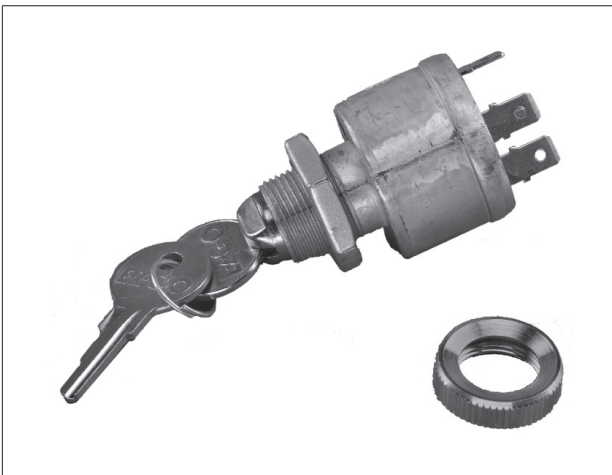

33639G01 STANDARD IGNITION SWITCH W/ LIGHTS
1996+ TXT



33639G02 NON-STANDARD IGNITION SWITCH W/
LIGHTS
1998-2011 TXT

ACCELERATOR

AIR CLEANER

BATTERY &
CHARGER

BODY & TRIM

CLUTCHES

DIRECTION
SELECTOR

ELECTRIC
MOTOR

**ELECTRICAL
SYSTEM**

ENGINE
& MUFFLER

FRONT
SUSPENSION
& STEERING

FUEL SYSTEM

ON THE
COURSE

REAR AXLE

REAR
SUSPENSION

SEATING

SPECIALTY
TOOLS

TOPS,
WINDSHIELDS
& PROTECTION

ELECTRICAL SYSTEM

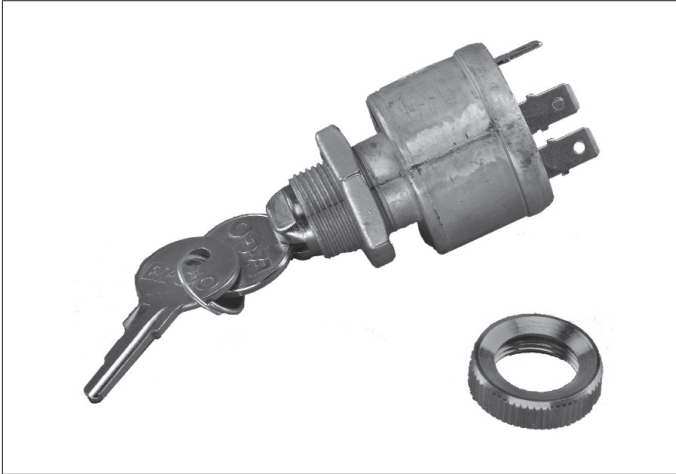

33639G03 INDIVIDUALLY KEYED IGNITION SWITCH W/
LIGHTS
1996+ TXT

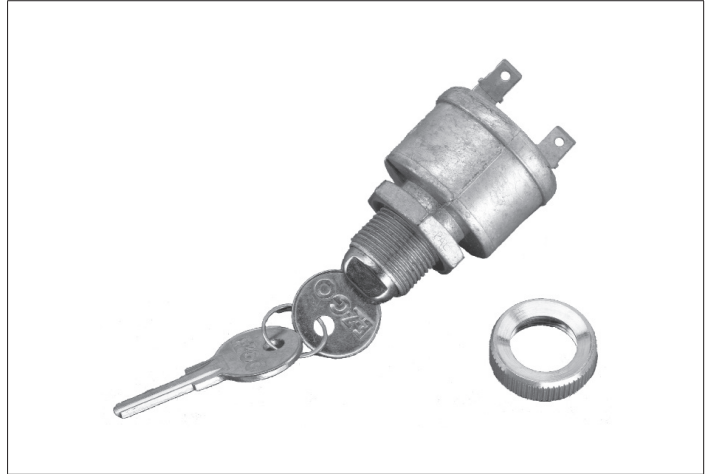

18027G1 UNIQUE KEY IGNITION SWITCH
2003+ TXT; 2017+ 72V TXT

LIGHTS



PART NUMBER	DESCRIPTION	VEHICLE
627117	KW COWL STANDARD HEADLIGHT KIT	2017+ 72V TXT
644876	RIGHT HAND HEADLIGHT ASSEMBLY	
644877	LEFT HAND HEADLIGHT ASSEMBLY	

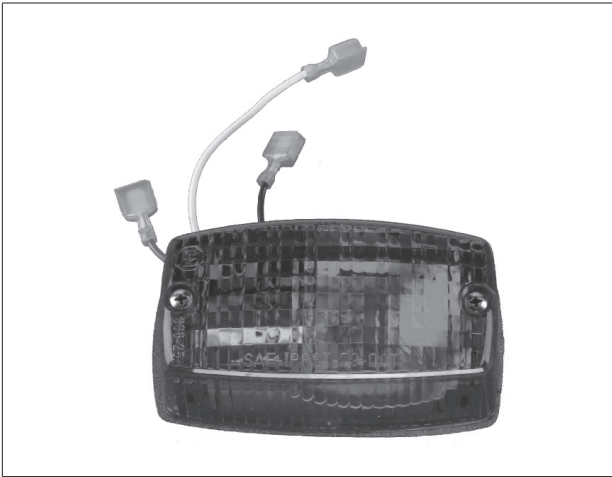

22288G1 COMPLETE TAIL LIGHT ASSEMBLY
1996+ TXT; 2017+ TXT ELITE; 2017+ 72V TXT



74004G01 12.8V BULB
1996-2013 TXT



75107G02 TXT TURN SIGNAL KIT
2003+ TXT



20468G1 36V SOLENOID
1996-2013 TXT



27855G01 36V SOLENOID
1996-2013 TXT



612632 48V CONTROLLER
2014+ TXT

ACCELERATOR

AIR CLEANER

BATTERY &
CHARGER

BODY & TRIM

CLUTCHES

DIRECTION
SELECTOR

ELECTRIC
MOTOR

**ELECTRICAL
SYSTEM**

ENGINE
& MUFFLER

FRONT
SUSPENSION
& STEERING

FUEL SYSTEM

ON THE
COURSE

REAR AXLE

REAR
SUSPENSION

SEATING

SPECIALTY
TOOLS

TOPS,
WINDSHIELDS
& PROTECTION

ELECTRICAL SYSTEM

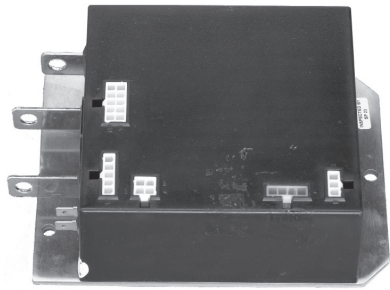

609083 PDS SPEED CONTROLLER
2009 TXT



612756 48V DC CONTROLLER ASSEMBLY
2010-2013 TXT

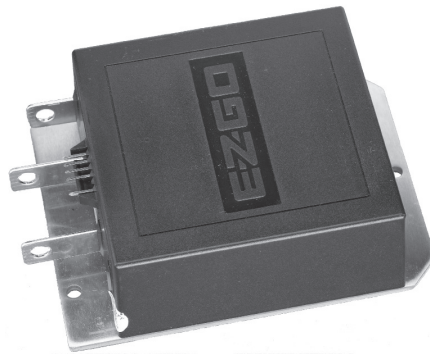

25864G09 ELECTRONIC SPEED CONTROLLER
1996-2011 TXT

666996G04 1236 AC CONTROLLER
2017+ 72V TXT



73060G01 1205 36V HD CONTROLLER
1996-2004 TXT

SPEED CONTROLLER COMPONENTS



620422 48V SPEED SENSOR HARNESS
2014+ TXT; 2017+ TXT ELITE

SWITCHES

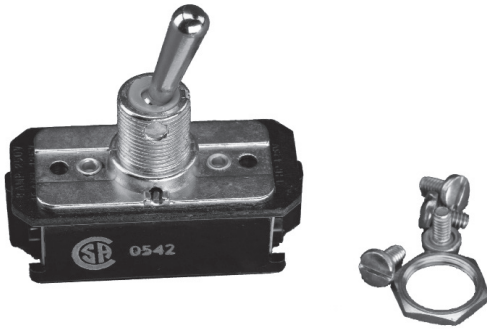

633114 RUN/TOW TOGGLE SWITCH
2014+ TXT; 2017+ TXT ELITE

TURN SIGNALS



615236 TURN SIGNAL SWITCH ASSEMBLY W/ HORN
2017+ 72V TXT

VOLTAGE REGULATOR



27739G01 VOLTAGE REGULATOR
1996+ TXT

ACCELERATOR

AIR CLEANER

BATTERY &
CHARGER

BODY & TRIM

CLUTCHES

DIRECTION
SELECTOR

ELECTRIC
MOTOR

**ELECTRICAL
SYSTEM**

ENGINE
& MUFFLER

FRONT
SUSPENSION
& STEERING

FUEL SYSTEM

ON THE
COURSE

REAR AXLE

REAR
SUSPENSION

SEATING

SPECIALTY
TOOLS

TOPS,
WINDSHIELDS
& PROTECTION



ENGINE

SUB SECTION	PAGE
AIR FILTER	55
BELTS	55
CARBURETOR & CHOKE	56
DIAGNOSTIC TOOL	56
ENGINE ASSEMBLY	56-59
HOUSING & COMPONENTS	60
MUFFLER	60
OIL FILTERS	61
STARTER GENERATOR	62

AIR FILTER



696008 EX1 AIR FILTER
2020+ VEHICLES WITH EX1 ENGINE



28463G01 AIR CLEANER ELEMENT
2007+ TTX555



72368G01 AIR FILTER ELEMENT
1996-2009 TXT

BELTS



26626G01 TIMING BELT
1996-2009 TXT

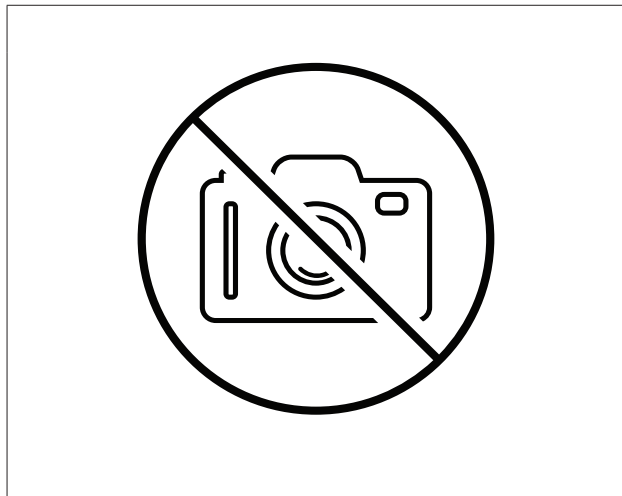

696533 EX1 DRIVE BELT
2020+ VEHICLES WITH EX1 ENGINE

ACCELERATOR

AIR CLEANER

BATTERY &
CHARGER

BODY & TRIM

CLUTCHES

DIRECTION
SELECTOR

ELECTRIC
MOTOR

ELECTRICAL
SYSTEM

ENGINE

FRONT
SUSPENSION
& STEERING

FUEL SYSTEM

ON THE
COURSE

REAR AXLE

REAR
SUSPENSION

SEATING

SPECIALTY
TOOLS

TOPS,
WINDSHIELDS
& PROTECTION

ENGINE

CARBURETOR & CHOKE

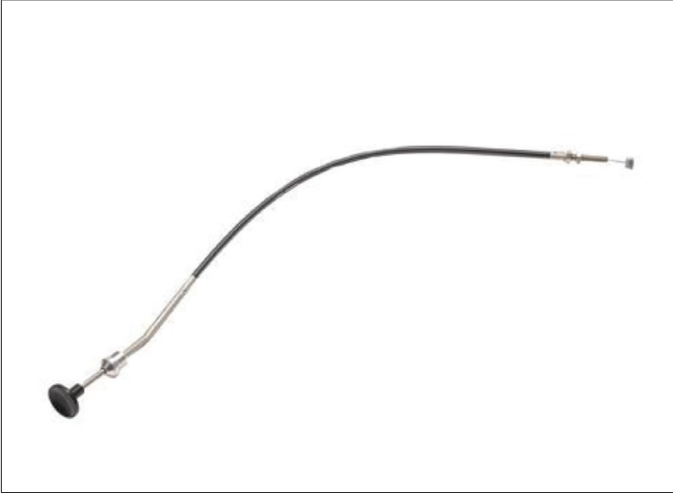

605868 CHOKE CABLE ASSEMBLY
2010+ TXT



607954 GOLF APPLICATION CARBURETOR
2010+ TXT

607955 NON-GOLF APPLICATION CARBURETOR
2010+ TXT



25693G04 CHOKE CONTROL
1996-2009 TXT

DIAGNOSTIC TOOLS



10001280 EX1 DIAGNOSTIC TOOL
2020+ VEHICLES WITH EX1 ENGINE

ENGINE ASSEMBLY

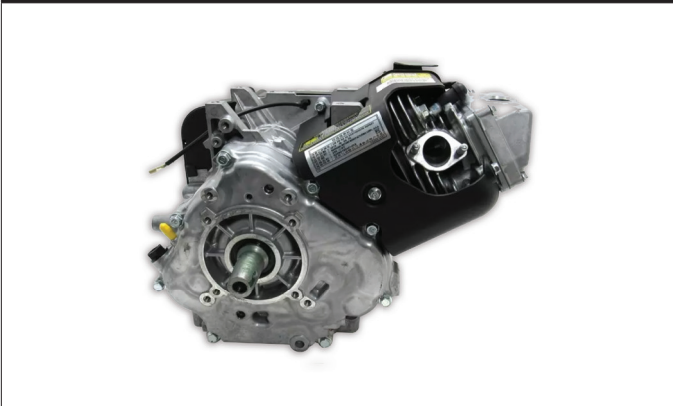

689380 13HP ENGINE
2010+ TXT



696497 EX1 SPARK PLUG
2020+ VEHICLES WITH EX1 ENGINE



684135 EX1 FUEL PUMP RELAY
2020+ VEHICLES WITH EX1 ENGINE



684128 EX1 ECU
2020+ VEHICLES WITH EX1 ENGINE



680387 EX1 ISG CONTROLLER
2020+ VEHICLES WITH EX1 ENGINE



680379 EX1 IGNITION COIL
2020+ VEHICLES WITH EX1 ENGINE



680380 EX1 THROTTLE BODY
2020+ VEHICLES WITH EX1 ENGINE



10001718 EX1 ECU BOOT
2020+ VEHICLES WITH EX1 ENGINE

ACCELERATOR

AIR CLEANER

BATTERY &
CHARGER

BODY & TRIM

CLUTCHES

DIRECTION
SELECTOR

ELECTRIC
MOTOR

ELECTRICAL
SYSTEM

ENGINE

FRONT
SUSPENSION
& STEERING

FUEL SYSTEM

ON THE
COURSE

REAR AXLE

REAR
SUSPENSION

SEATING

SPECIALTY
TOOLS

TOPS,
WINDSHIELDS
& PROTECTION

ENGINE



696600 EX1 CVT SHOE
2020+ VEHICLES WITH EX1 ENGINE



696602 EX1 CVT SHOE SPRING
2020+ VEHICLES WITH EX1 ENGINE



696641 EX1 VAPOR HOSE
2020+ VEHICLES WITH EX1 ENGINE



696523 EX1 STATOR
2020+ VEHICLES WITH EX1 ENGINE



606067 ROLLOVER VALVE
2010+ TXT



606390 OIL DIPSTICK
2010+ TXT



606391 HIGH SUSPENSION OIL DIPSTICK
2010+ TXT



607462 SPARK PLUG
2010+ TXT



25523G3 SPARK PLUG
1996-2006 TXT



26302G01 MACHINED FIXED CAM
1996-2009 TXT



696012 EX1 DIP STICK
2020+ VEHICLES WITH EX1 ENGINE



680373 EX1 O2 SENSOR
2020+ VEHICLES WITH EX1 ENGINE

ACCELERATOR

AIR CLEANER

BATTERY &
CHARGER

BODY & TRIM

CLUTCHES

DIRECTION
SELECTOR

ELECTRIC
MOTOR

ELECTRICAL
SYSTEM

ENGINE

FRONT
SUSPENSION
& STEERING

FUEL SYSTEM

ON THE
COURSE

REAR AXLE

REAR
SUSPENSION

SEATING

SPECIALTY
TOOLS

TOPS,
WINDSHIELDS
& PROTECTION

ENGINE

HOUSING & COMPONENTS



28462G01 DUST EJECTOR VALVE
2007+ TXT



72151G01 AIR INTAKE HOSE
1996-2009 TXT



72178G01 AIR FILTER HOUSING
1996-2009 TXT

MUFFLER



606982 EXHAUST PIPE HEADER
2010+ TXT



630970 KAWASAKI MUFFLER
2010+ TXT
612266 KAWASAKI MUFFLER
1996+ TXT

OIL FILTERS



70694G01 INNER ROD END
2001+ TXT



607454 OIL FILTER
2010+ TXT

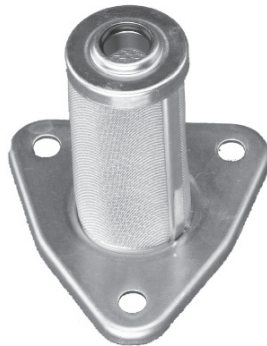

26591G01 OIL FILTER
1996-2009 TXT

ACCELERATOR

AIR CLEANER

BATTERY &
CHARGER

BODY & TRIM

CLUTCHES

DIRECTION
SELECTOR

ELECTRIC
MOTOR

ELECTRICAL
SYSTEM

ENGINE

FRONT
SUSPENSION
& STEERING

FUEL SYSTEM

ON THE
COURSE

REAR AXLE

REAR
SUSPENSION

SEATING

SPECIALTY
TOOLS

TOPS,
WINDSHIELDS
& PROTECTION

STARTER GENERATOR



630587 STARTER GENERATOR BELT
2010+ TXT



631972 STARTER GENERATOR SUPPORT WELDMENT BRACKET
2010+ TXT



660379 STARTER GENERATOR
2010+ TXT



FRONT SUSPENSION & STEERING

SUB SECTION	PAGE
LEAF SPRINGS	64
SPINDLES & HUBS	64-66
STEERING COLUMNS & COMPONENTS	66-67
STEERING RACK & COMPONENTS	67-69
TIE RODS	70

FRONT SUSPENSION & STEERING

LEAF SPRINGS



70049G01 FRONT LEAF SPRING
1996-2001 TXT



70664G03 185 SILVER FRONT SPRING
2007-2012 TXT

SPINDLES & HUBS



19932G1 FRONT HUB ASSEMBLY
1996-2000 TXT



70221G01 RIGHT HAND SPINDLE & HUB ASSEMBLY
1996-2001 TXT

70220G01 LEFT HAND SPINDLE & HUB ASSEMBLY
1996-2001 TXT



70328G01 SPINDLE TUBE PIN
1996-2001 TXT



70589G01 WHEEL HUB
2014+ TXT; 2017+ TXT ELITE; 2017+ 72V TXT

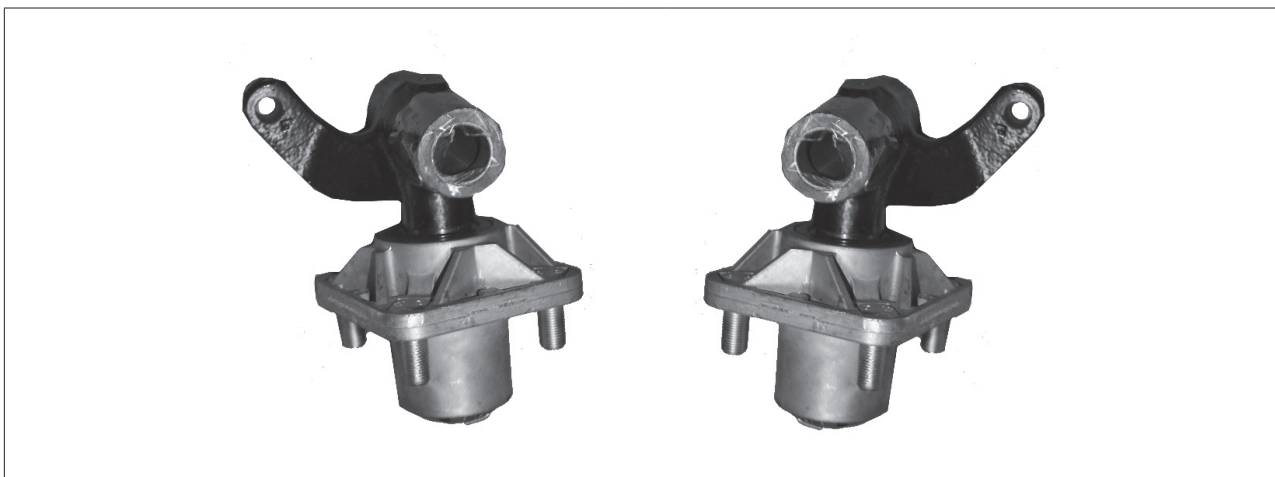

70673G03 LEFT HAND SPINDLE ASSEMBLY
2001+ TXT; 2017+ TXT ELITE; 2017+ 72V TXT

70942G03 RIGHT HAND SPINDLE ASSEMBLY
2007+ TXT; 2017+ TXT ELITE; 2017+ 72V TXT



70673G04 LEFT HAND SPINDLE ASSEMBLY
2001+ TXT; 2017+ TXT ELITE; 2017+ 72V TXT

ACCELERATOR

AIR CLEANER

BATTERY &
CHARGER

BODY & TRIM

CLUTCHES

DIRECTION
SELECTOR

ELECTRIC
MOTOR

ELECTRICAL
SYSTEM

ENGINE

**FRONT
SUSPENSION
& STEERING**

FUEL SYSTEM

ON THE
COURSE

REAR AXLE

REAR
SUSPENSION

SEATING

SPECIALTY
TOOLS

TOPS,
WINDSHIELDS
& PROTECTION

FRONT SUSPENSION & STEERING

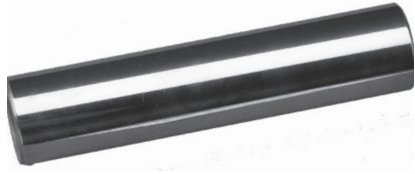

70745G01 KINGPIN
2001+ TXT; 2017+ TXT ELITE; 2017+ 72V TXT



70895G01 4 BOLT HUB ASSEMBLY
2001-2013 TXT

STEERING COLUMNS & COMPONENTS



70580G01 INTERMEDIATE SHAFT ASSEMBLY
2001+ TXT; 2017+ TXT ELITE; 2017+ 72V TXT



70607G01 STEERING SHAFT
2001+ TXT; 2017+ TXT ELITE; 2017+ 72V TXT



70610G03 STEERING COLUMN ASSEMBLY
2001+ TXT; 2017+ TXT ELITE; 2017+ 72V TXT



70758G05 STEERING COLUMN ASSEMBLY
2001+ TXT; 2017+ TXT ELITE; 2017+ 72V TXT



70997G01 STEERING COLUMN BASE COVER
2003+ TXT; 2017+ TXT ELITE; 2017+ 72V TXT



28633G01 STEERING COLUMN KIT
1996-2001 TXT

STEERING RACKS & COMPONENTS



70360G01 STEERING SHAFT & COLUMN KIT
1996-2001 TXT



70603G01 PINION
2014+ TXT; 2017+ TXT ELITE

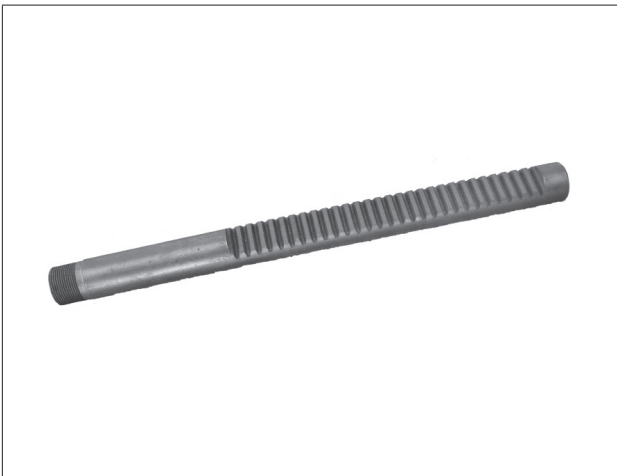

70604G01 RACK
2014+ TXT; 2017+ TXT ELITE; 2017+ 72V TXT



70961G01 RACK BELLOWS COVER
2007+ TXT; 2017+ TXT ELITE; 2017+ 72V TXT

ACCELERATOR

AIR CLEANER

BATTERY &
CHARGER

BODY & TRIM

CLUTCHES

DIRECTION
SELECTOR

ELECTRIC
MOTOR

ELECTRICAL
SYSTEM

ENGINE

**FRONT
SUSPENSION
& STEERING**

FUEL SYSTEM

ON THE
COURSE

REAR AXLE

REAR
SUSPENSION

SEATING

SPECIALTY
TOOLS

TOPS,
WINDSHIELDS
& PROTECTION

FRONT SUSPENSION & STEERING



70964G01 STEERING BOX ASSEMBLY
2003+ TXT; 2017+ TXT ELITE; 2017+ 72V TXT



70965G01 STEERING RACK COVER W/ BEARING
2007+ TXT; 2017+ TXT ELITE; 2017+ 72V TXT



602981 TIE ROD ASSEMBLY
2005-2013 TXT



24479G1 BALL JOINT
1996-2002 TXT



70041G01 STEERING BOX RACK COVER
1996-2001 TXT



70179G01 STEERING RACK TENSIONER GUIDE
1996-2001 TXT



70183G01 RACK BELLOWS COVER
1996-2001 TXT



70192G01 RACK BALL END
1996-2001 TXT

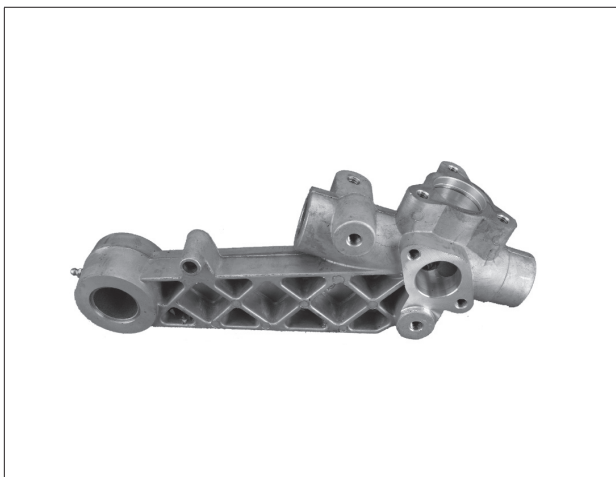

75364G01 STEERING HOUSING SERVICE KIT
1996-2001 TXT



70558G01 STEERING COUPLING
1998-2001 TXT

ACCELERATOR

AIR CLEANER

BATTERY &
CHARGER

BODY & TRIM

CLUTCHES

DIRECTION
SELECTOR

ELECTRIC
MOTOR

ELECTRICAL
SYSTEM

ENGINE

**FRONT
SUSPENSION
& STEERING**

FUEL SYSTEM

ON THE
COURSE

REAR AXLE

REAR
SUSPENSION

SEATING

SPECIALTY
TOOLS

TOPS,
WINDSHIELDS
& PROTECTION

FRONT SUSPENSION & STEERING

TIE RODS



70897G02 24 INCH THREADED TIE ROD
2002+ TXT; 2017+ TXT ELITE; 2017+ 72V TXT



70876G02 26.44 INCH TIE ROD ASSEMBLY
2005+ TXT; 2017+ TXT ELITE; 2017+ 72V TXT



70902G01 LEFT HAND TIE ROD END
2001+ TXT; 2017+ TXT ELITE; 2017+ 72V TXT

70902G02 RIGHT HAND TIE ROD END
2002+ TXT; 2017+ TXT ELITE; 2017+ 72V TXT



27205G01 LEFT HAND TIE ROD END
1996-2013 TXT

27205G02 RIGHT HAND TIE ROD END
1996-2013 TXT



FUEL SYSTEM

SUB SECTION	PAGE
FUEL FILTERS	72
FUEL PUMPS	72
FUEL TANKS	72-73
SENDING UNITS	73
SIPHON TUBES	73

FUEL SYSTEM

FUEL FILTERS

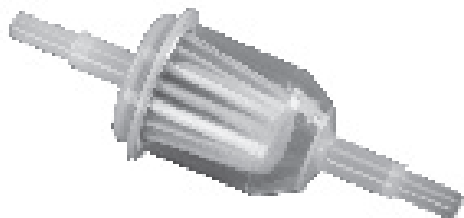

72084G01 FUEL FILTER
1996+ TXT

FUEL PUMPS



602061 FUEL PUMP
2010+ TXT

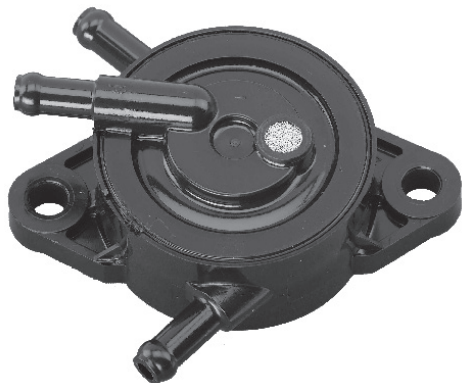

72873G01 FUEL PUMP
2007-2009 TXT

FUEL TANKS



656139 FUEL TANK WITH SENDER ASSEMBLY
2014+ TXT



656138 FUEL TANK WITHOUT SENDER ASSEMBLY
2014+ TXT



750609PKG PRE 2016 FUEL TANK SWAP KIT WITH SENDER
1996-2015 TXT



750643PKG PRE 2016 FUEL TANK SWAP KIT WITHOUT SENDER
1996-2015 TXT

SENDING UNITS



656144 FUEL PICKUP WITH SENDER
2014+ TXT



20048G2 FUEL LEVEL SENDER
1996+ TXT

SIPHON TUBES



18287G3 SIPHON TUBE ASSEMBLY
2010+ TXT

ACCELERATOR

AIR CLEANER

BATTERY & CHARGER

BODY & TRIM

CLUTCHES

DIRECTION SELECTOR

ELECTRIC MOTOR

ELECTRICAL SYSTEM

ENGINE

FRONT SUSPENSION & STEERING

FUEL SYSTEM

ON THE COURSE

REAR AXLE

REAR SUSPENSION

SEATING

SPECIALTY TOOLS

TOPS, WINDSHIELDS & PROTECTION



ON THE COURSE

SUB SECTION	PAGE
BAG ATTACHMENTS	75
SAND BOTTLES & BUCKETS	75
TOW BAR	75

BAG ATTACHMENTS



71853G01 BAG RETAINER STRAP
1996+ TXT; 2017+ TXT ELITE; 2017+ 72V TXT



750130PKG BAG HOLDER REPLACEMENT PACKAGE
1996+ TXT; 2017+ TXT ELITE; 2017+ 72V TXT

SAND BOTTLES & BUCKETS



662248 SAND BUCKET
2014+ TXT



28659G01 SAND BOTTLE
2001+ TXT; 2017+ TXT ELITE; 2017+ 72V TXT

TOW BAR



75033G01 TOW BAR ASSEMBLY
1996-2013 TXT

ACCELERATOR

AIR CLEANER

BATTERY &
CHARGER

BODY & TRIM

CLUTCHES

DIRECTION
SELECTOR

ELECTRIC
MOTOR

ELECTRICAL
SYSTEM

ENGINE

FRONT
SUSPENSION
& STEERING

FUEL SYSTEM

**ON THE
COURSE**

REAR AXLE

REAR
SUSPENSION

SEATING

SPECIALTY
TOOLS

TOPS,
WINDSHIELDS
& PROTECTION



REAR AXLE

SUB SECTION	PAGE
AXLE ASSEMBLIES	77
REAR AXLE ASM	77
REAR AXLE COMPONENTS	78-79

AXLE ASSEMBLIES



670468 11.47:1 FUJI GAS AXLE
2010+ TXT

670470 11.47:1 FUJI GAS AXLE WITH LIMITED SLIP
DIFFERENTIAL
2010+ TXT

REAR AXLE ASM



633599 16.99:1 AC ELECTRIC REAR AXLE
2017+ 72V TXT; 2018+ EXPRESS

633600 16.99:1 AC ELECTRIC REAR AXLE
2017+ 72V TXT

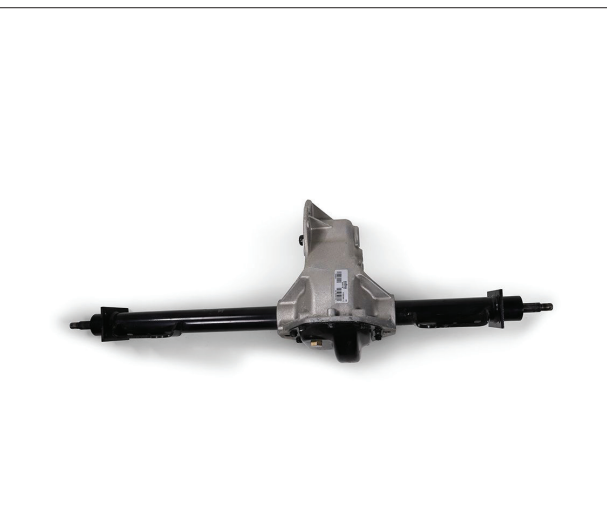

73500G01 12.44:1 ELECTRIC REAR AXLE
2001+ TXT; 2017+ TXT ELITE

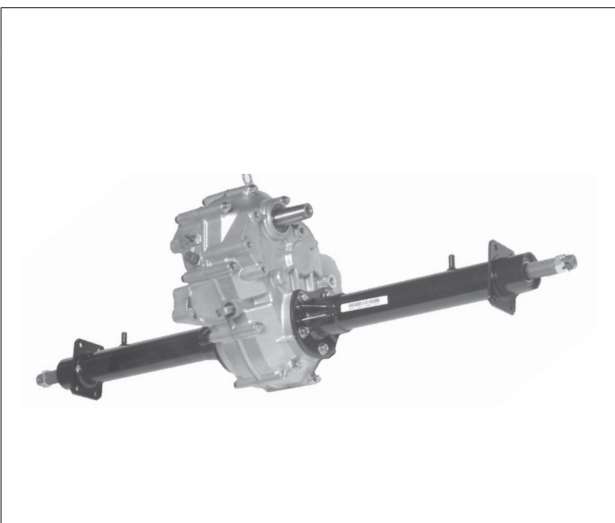

627891 GAS FUJI AXLE
2010-2015 TXT

ACCELERATOR

AIR CLEANER

BATTERY &
CHARGER

BODY & TRIM

CLUTCHES

DIRECTION
SELECTOR

ELECTRIC
MOTOR

ELECTRICAL
SYSTEM

ENGINE

FRONT
SUSPENSION
& STEERING

FUEL SYSTEM

ON THE
COURSE

REAR AXLE

REAR
SUSPENSION

SEATING

SPECIALTY
TOOLS

TOPS,
WINDSHIELDS
& PROTECTION

REAR AXLE

REAR AXLE COMPONENTS



620327 INPUT GEAR
2017+ 72V TXT; 2009+ TXT



620329 INPUT GEAR KIT
2017+ 72V TXT; 2009+ TXT



620348 DIFFERENTIAL PLATE COVER
2014+ TXT; 2017+ TXT ELITE; 2017+ 72V TXT



620349 INTERMEDIATE GEAR ASSEMBLY
2017+ 72V TXT

629151 INDEPENDENT DIFFERENTIAL HARDENED GEARS
2017+ 72V TXT



601085 DIFFERENTIAL COVER W/ PLUG
2002+ TXT



50641G1 RUBBER BOOT
1996+ TXT; 2017+ TXT ELITE; 2017+ 72V TXT



PART NUMBER	DESCRIPTION	VEHICLE
614209	16.25 INCH RIGHT HAND AXLE SHAFT	2014+ TXT; 2017+ TXT ELITE
614208	24.75 INCH LEFT HAND REAR AXLE SHAFT	
639876	LEFT HAND AXLE SHAFT	2014+ TXT
639881	RIGHT HAND AXLE SHAFT	
20377G12	16.75 INCH RH REAR AXLE	1996+ TXT
72056G01	LEFT HAND REAR AXLE SHAFT	1996-2008 TXT
72057G01	RIGHT HAND AXLE SHAFT	
20377G11	23.84 INCH LH REAR AXLE	1996+ TXT

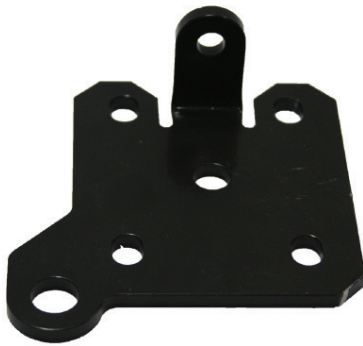

605938 LEFT HAND AXLE BRACKET
605958 RIGHT AHND AXLE BRACKET
 2010+ TXT



73050G01 DANA AXLE PUSH IN VENT ASSEMBLY
 1996+ TXT; 2017+ TXT ELITE



612556 12.44:1 INPUT SHAFT KIT W/ BEARINGS
 1996-2013 TXT

ACCELERATOR

AIR CLEANER

BATTERY &
CHARGER

BODY & TRIM

CLUTCHES

DIRECTION
SELECTOR

ELECTRIC
MOTOR

ELECTRICAL
SYSTEM

ENGINE

FRONT
SUSPENSION
& STEERING

FUEL SYSTEM

ON THE
COURSE

REAR AXLE

REAR
SUSPENSION

SEATING

SPECIALTY
TOOLS

TOPS,
WINDSHIELDS
& PROTECTION



REAR SUSPENSION

SUB SECTION	PAGE
LEAF SPRINGS	81-83
MOUNTING PLATES & HARDWARE	83
SHOCK ABSORBERS	83-84

LEAF SPRINGS



603109 380 REAR LEAF SPRING
2001+ TXT



627426 280 REAR SPRING
2010+ TXT



70505G01 STANDARD REAR 3 LEAF SPRING SET
1996-2006 TXT



70506G01 HD REAR 4 LEAF SPRING SET
1996-2006 TXT



74207G03 440 RED REAR SPRING
2001+ TXT; 2017+ TXT ELITE; 2017+ 72V TXT

ACCELERATOR

AIR CLEANER

BATTERY &
CHARGER

BODY & TRIM

CLUTCHES

DIRECTION
SELECTOR

ELECTRIC
MOTOR

ELECTRICAL
SYSTEM

ENGINE

FRONT
SUSPENSION
& STEERING

FUEL SYSTEM

ON THE
COURSE

REAR AXLE

**REAR
SUSPENSION**

SEATING

SPECIALTY
TOOLS

TOPS,
WINDSHIELDS
& PROTECTION

REAR SUSPENSION



605721 520 WHITE REAR LEAF SPRING
2010+ TXT



605722 450 IVORY REAR LEAF SPRING
2009+ TXT



70989G03 150 PINK FRONT LEAF SPRING
2005+ TXT; 2017+ 72V TXT



70990G03 LEAF SPRING
2014+ TXT; 2017+ TXT ELITE



652246 ECOAT REAR SUSPENSION PLATE
2014+ TXT



652258 ECOAT SPRING PLATE
2014+ TXT; 2017+ TXT ELITE; 2017+ 72V TXT

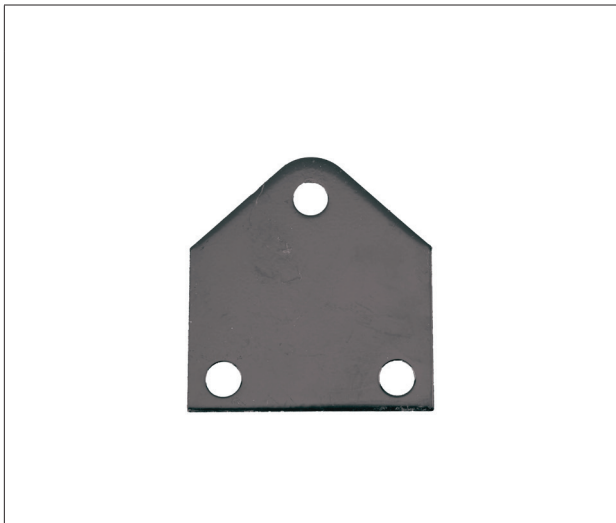

70540G02 SPRING PLATE
1998-2001 TXT

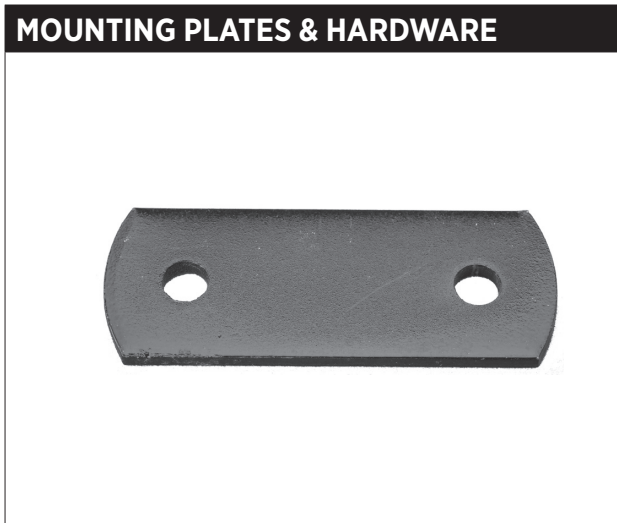

652245 ECOAT SHACKLE PLATE
2014+ TXT; 2017+ TXT ELITE



604961 SHACKLE PLATE
2009+ TXT; 2017+ 72V TXT



750117PKG 4 LEAF REAR SHOCK PACKAGE
2005+ TXT; 2017+ TXT ELITE



76418G01 SHOCK ABSORBER
2005+ TXT; 2017+ TXT ELITE



642085 HEAVY DUTY REAR SHOCK ABSORBER
2010+ TXT; 2017+ 72V TXT

MOUNTING PLATES & HARDWARE

SHOCK ABSORBERS

ACCELERATOR

AIR CLEANER

BATTERY &
CHARGER

BODY & TRIM

CLUTCHES

DIRECTION
SELECTOR

ELECTRIC
MOTOR

ELECTRICAL
SYSTEM

ENGINE

FRONT
SUSPENSION
& STEERING

FUEL SYSTEM

ON THE
COURSE

REAR AXLE

**REAR
SUSPENSION**

SEATING

SPECIALTY
TOOLS

TOPS,
WINDSHIELDS
& PROTECTION

REAR SUSPENSION



76419G01 SHOCK ABSORBER W/INTERNAL BUMPER
2005+ TXT; 2017+ TXT ELITE; 2017+ 72V TXT



SEATING

SUB SECTION	PAGE
HIP RESTRAINTS	86
PREMIUM SEAT ASMS	86
SEAT BACKS	86
SEAT BOTTOMS	87-88
SEAT COMPONENTS	88
SEAT COVERS	89
SEAT PACKAGES	90

SEATING

HIP RESTRAINTS



PART NUMBER	DESCRIPTION	VEHICLE
71701G01	PASSENGERS SIDE HIP RESTRAINT	1996-2011 TXT
71702G01	DRIVERS SIDE HIP RESTRAINT	
617644	PASSENGERS SIDE HIP RESTRAINT	2014+ TXT; 2017+ TXT ELITE; 2017+ 72V TXT
617645	DRIVERS SIDE HIP RESTRAINT	

PREMIUM SEAT ASSEMBLIES

FRONT ASM	BACK ASM	DESCRIPTION	VEHICLE
654084G17	629269G1917	LIGHT BEIGE	2014+ TXT; 2017+ TXT ELITE; 2017+ 72V TXT
654084G18	629269G1918	MUSHROOM	
654084G21	629269G1921	BLACK	

SEAT BACKS



PART NUMBER	DESCRIPTION	VEHICLE
625229G0101	LARGE OYSTER SEAT BACK ASSEMBLY	2014+ TXT; 2017+ TXT ELITE
625229G0106	LARGE BLACK SEAT BACK ASSEMBLY	
625229G0103	LARGE TAN SEAT BACK ASSEMBLY	
71751G01	WHITE SEAT BACK ASSEMBLY	1996-2011 TXT
71751G03	OYSTER SEAT BACK ASSEMBLY	
71751G04	TAN SEAT BACK ASSEMBLY	
71751G07	BLACK SEAT BACK ASSEMBLY	

SEAT BOTTOMS



71811G03 SEAT BACK BRACKET
2005+ TXT; 2017+ TXT ELITE; 2017+ 72V TXT



PART NUMBER	DESCRIPTION	VEHICLE
629269G0101	OYSTER SEAT BOTTOM ASSEMBLY	2014+ TXT; 2017+ TXT ELITE; 2017+ 72V TXT
629269G0103	TAN SEAT BOTTOM ASSEMBLY	
629269G0104	GRAY SEAT BOTTOM ASSEMBLY	
629269G0105	WHITE SEAT BOTTOM ASSEMBLY	
629269G0106	BLACK SEAT BOTTOM ASSEMBLY	

ACCELERATOR

AIR CLEANER

BATTERY &
CHARGER

BODY & TRIM

CLUTCHES

DIRECTION
SELECTOR

ELECTRIC
MOTOR

ELECTRICAL
SYSTEM

ENGINE

FRONT
SUSPENSION
& STEERING

FUEL SYSTEM

ON THE
COURSE

REAR AXLE

REAR
SUSPENSION

SEATING

SPECIALTY
TOOLS

TOPS,
WINDSHIELDS
& PROTECTION

SEATING



PART NUMBER	DESCRIPTION	VEHICLE
699321G01	OYSTER SEAT BOTTOM ASSEMBLY	2014+ TXT; 2017+ TXT ELITE; 2017+ 72V TXT
699321G03	TAN SEAT BOTTOM ASSEMBLY	
699321G06	BLACK SEAT BOTTOM ASSEMBLY	
71664G07	TAN SEAT BOTTOM ASSEMBLY	1996-2011 TXT
71611G08	TAN SEAT BOTTOM ASSEMBLY	
74139G04	TAN REAR SEAT BOTTOM	1996+ TXT; 2017+ TXT ELITE
75197G04	TAN SEAT BOTTOM ASSEMBLY	1996-2009 TXT

SEAT COMPONENTS



PART NUMBER	DESCRIPTION	VEHICLE
634179	FOOTREST WELDMENT	2014+ TXT; 2017+ TXT ELITE; 2017+ 72V TXT
634178	SEAT BACK SUPPORT WELDMENT	
70361G01	FOOTREST ASSEMBLY	1996+ TXT; 2017+ TXT ELITE; 2017+ 72V TXT
70633G01	FOOTREST WELDMENT	
71012G01	SEAT BOTTOM TRIM	
71603G02	SEAT BOTTOM FOAM	

SEAT COVERS



PART NUMBER	DESCRIPTION	VEHICLE
625239	SEAT BACK COVER	2014+ TXT; 2017+ TXT ELITE
625234G03	TAN SEAT BACK COVER	
625234G06	BLACK SEAT BACK COVER	
71602G01	WHITE SEAT BOTTOM COVER	1996+ TXT; 2017+ 72V TXT
71602G02	GRAY SEAT BOTTOM COVER	
71602G03	OYSTER SEAT BOTTOM COVER	
71602G04	TAN SEAT BOTTOM COVER	
71602G06	BLACK SEAT BOTTOM COVER	
71752G01	PLASTIC SEAT BACK COVER	
71753G01	WHITE SEAT BACK COVER	
71753G04	TAN SEAT BACK COVER	
71753G07	BLACK SEAT BACK COVER	

ACCELERATOR

AIR CLEANER

BATTERY &
CHARGER

BODY & TRIM

CLUTCHES

DIRECTION
SELECTOR

ELECTRIC
MOTOR

ELECTRICAL
SYSTEM

ENGINE

FRONT
SUSPENSION
& STEERING

FUEL SYSTEM

ON THE
COURSE

REAR AXLE

REAR
SUSPENSION

SEATING

SPECIALTY
TOOLS

TOPS,
WINDSHIELDS
& PROTECTION

SEAT PACKAGES



PART NUMBER	DESCRIPTION	VEHICLE
FRONT SEAT COVERS ONLY		1996+ TXT; 2017+ TXT ELITE; 2017+ 72V TXT
750290PKG	BLACK SEAT BOTTOM AND BACK COVER PACKAGE	
750320PKG	TAN SEAT BOTTOM AND BACK COVER PACKAGE	
BACK COVERS ONLY		
750118PKG	WHITE SEAT BOTTOM AND BACK PACKAGE	
750119PKG	GRAY SEAT BOTTOM AND BACK PACKAGE	
750120PKG	OYSTER SEAT BOTTOM AND BACK PACKAGE	
750121PKG	TAN SEAT BOTTOM AND BACK PACKAGE	
750295PKG	BLACK SEAT BOTTOM AND BACK PACKAGE	



SPECIALTY TOOLS

SUB SECTION	PAGE
DIAGNOSTIC TOOLS	92

DIAGNOSTIC TOOLS



664487 SAMSUNG SDI BATTERY DIAGNOSTIC TOOL
2017+ TXT ELITE



TOPS, WINDSHIELDS & PROTECTION

SUB SECTION	PAGE
54" TOP KITS	94
80" TOP KITS	94
116" TOP KITS	95

TOPS, WINDSHIELDS & PROTECTION



54" TOP KITS

TOP KITS/TOPS/STRUTS				54" COMPATIBLE WINDSHIELDS		
TOP KIT	TOP	STRUTS	COLOR	SPLIT/CLEAR	FULL/CLEAR	TINTED
750552PKG	625290	635005	TAN	X	X	X
751251PKG	625291	635005	BEIGE	X	X	X
751252PKG	625292	635005	BLACK	X	X	X



80" TOP KITS

TOP KITS/TOPS/STRUTS				80" COMPATIBLE WINDSHIELDS			
TOP KIT	TOP	STRUTS	COLOR	625279G02*	625279G04*	625279G05**	625279G06**
				SPLIT/CLEAR	FULL/CLEAR	SPLIT/CLEAR	FULL/CLEAR
634553G01	602672	634791/602741/ 602743	TAN	X	X	X	X
634553G02	27604G01	634791/602741/ 602743	WHITE	X	X	X	X
634553G03	606937	634791/602741/ 602743	BLACK	X	X	X	X
751462PKG	687855	634791/602741/ 602743	GREY	X	X	X	X

*Windshield fits TXT gas and 48V

**Windshields fit 72V only

116" TOP KITS



PART NUMBER	DESCRIPTION	VEHICLE
610267	BEIGE	TXT SHUTTLE
610266	WHITE	
610268	BLACK	

ACCELERATOR

AIR CLEANER

BATTERY &
CHARGER

BODY & TRIM

CLUTCHES

DIRECTION
SELECTOR

ELECTRIC
MOTOR

ELECTRICAL
SYSTEM

ENGINE

FRONT
SUSPENSION
& STEERING

FUEL SYSTEM

ON THE
COURSE

REAR AXLE

REAR
SUSPENSION

SEATING

SPECIALTY
TOOLS

**TOPS,
WINDSHIELDS
& PROTECTION**

RXV 2008- CURRENT





RXV TABLE OF CONTENTS

Accelerator	98-99
Battery & Charger	100-103
Body & Trim	104-114
Clutches	115-117
Direction Selector	118-119
Electric Motor	120-121
Electrical System	122-128
Engine	129-134
Front Suspension & Steering	135-138
Fuel System	139-140
On the Course	141-143
Rear Axle	144-147
Rear Suspension	148-150
Seating	151-154
Specialty Tools	155-156
Tops, Windshields & Protection	157-159



ACCELERATOR

SUB SECTION	PAGE
SWITCHES	99

SWITCHES

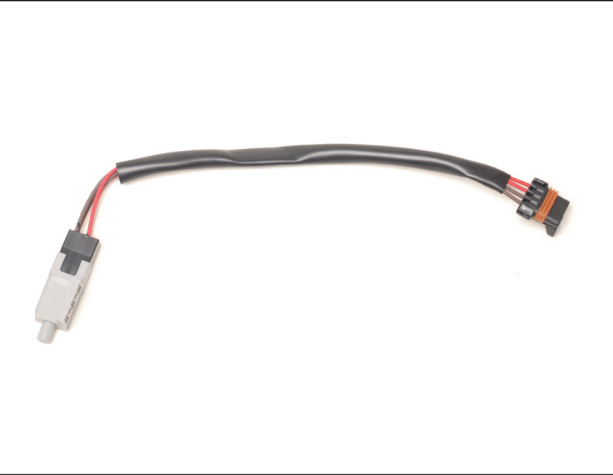

607605 BRAKE AND ACCELERATOR PEDAL SWITCH
2008+ RXV; 2017+ RXV ELITE



612889 MOLEX PEDAL SWITCH
2009+ RXV; 2010+ 2FIVE

ACCELERATOR

AIR CLEANER

BATTERY
& CHARGER

BODY & TRIM

CLUTCHES

DIRECTION
SELECTOR

ELECTRIC
MOTOR

ELECTRICAL
SYSTEM

ENGINE
& MUFFLER

FRONT
SUSPENSION
& STEERING

FUEL SYSTEM

ON THE
COURSE

REAR AXLE

REAR
SUSPENSION

SEATING

SPECIALTY
TOOLS

TOPS,
WINDSHIELDS
& PROTECTION



BATTERY & CHARGERS

SUB SECTION	PAGE
BATTERY WATERING SYSTEM & COMPONENTS	101
CABLES & WIRING	101-102
CHARGERS	102-103
HOLD DOWNS & STRAPS	103
LITHIUM	103

BATTERY WATERING SYSTEM



609801 RXV BATTERY FILL SYSTEM
2008+ RXV

CABLES & WIRING



602529 48V CHARGER RECEPTACLE
2008+ RXV



602930 6AWG 261MM BLUE WIRE ASSEMBLY
2008+ RXV; 2010+ 2FIVE

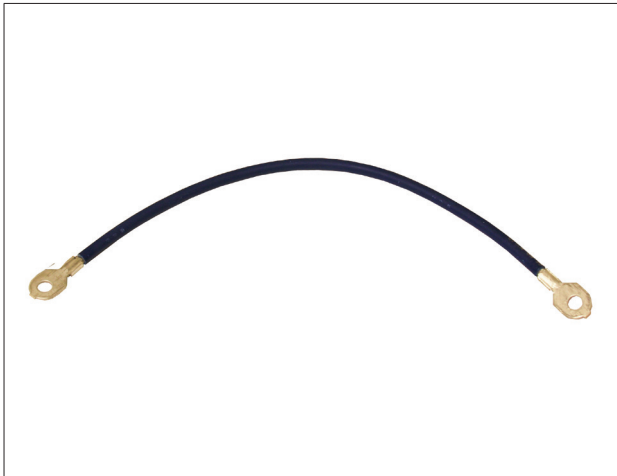

613236 6AWG 380MM BLUE WIRE ASSEMBLY
2009+ RXV; 2010+ 2FIVE



613237 6AWG 150MM BLUE WIRE ASSEMBLY
2009+ RXV; 2010+ 2FIVE



607057 6AWG 325MM BLUE WIRE ASSEMBLY
2008+ RXV; 2010+ 2FIVE

ACCELERATOR

AIR CLEANER

**BATTERY
& CHARGER**

BODY & TRIM

CLUTCHES

DIRECTION
SELECTOR

ELECTRIC
MOTOR

ELECTRICAL
SYSTEM

ENGINE
& MUFFLER

FRONT
SUSPENSION
& STEERING

FUEL SYSTEM

ON THE
COURSE

REAR AXLE

REAR
SUSPENSION

SEATING

SPECIALTY
TOOLS

TOPS,
WINDSHIELDS
& PROTECTION

BATTERY & CHARGER



610536 ON-BOARD CHARGER RECETACLE
2010+ 2FIVE



619996 RXV/2FIVE BATTERY WIRING KIT
2008+ RXV; 2010+ 2FIVE



651410 LITHIUM RXV CHARGER RECEPTACLE
2017+ RXV ELITE

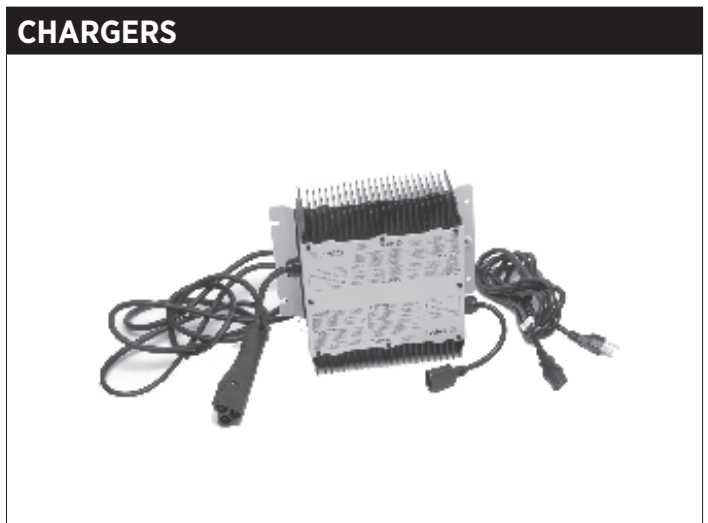

622419 48V WORLD CHARGER W/ 3M CORD
2008+ RXV



635671 48V CHARGER W/ 3M CORD
2008+ RXV



653213 LITHIUM CHARGER W/ 3M CORD
2017+ RXV ELITE;



653214 LITHIUM CHARGER W/ 3M CORD
2017+ RXV ELITE



632862 48V ON-BOARD CHARGER W/ DC-DC
CONVERTER
2010+ 2FIVE

HOLD DOWNS & STRAPS



602896 BATTERY HOLD DOWN ROD
2008+ RXV



627889 RXV BATTERY TRAY KIT
2008+ RXV

LITHIUM



696855 BATTERY MANAGEMENT SYSTEM
2017+ RXV ELITE



665954 30AH CELL MODULE
2017+ RXV ELITE

ACCELERATOR

AIR CLEANER

**BATTERY
& CHARGER**

BODY & TRIM

CLUTCHES

DIRECTION
SELECTOR

ELECTRIC
MOTOR

ELECTRICAL
SYSTEM

ENGINE
& MUFFLER

FRONT
SUSPENSION
& STEERING

FUEL SYSTEM

ON THE
COURSE

REAR AXLE

REAR
SUSPENSION

SEATING

SPECIALTY
TOOLS

TOPS,
WINDSHIELDS
& PROTECTION



BODY & TRIM

SUB SECTION	PAGE
ACCESS PANEL	104
BAGWELL LINER	104
BODY & COWLS	106-107
BUMPERS & BRUSHGUARDS	108-109
FLOOR MATS	110
FRAMES	110
FRONT SHIELDS	111
INSTRUMENT PANEL	111-112
MIRRORS	113
REFLECTORS	113
ROCKER PANELS & SILL PLATES	113
SCUFF GUARDS	114
STRETCH KITS	114

ACCESS PANEL



600249 REAR BODY ACCESS PANEL
2008-2015 RXV; 2010-2015 2FIVE

650443 ACCESS PANEL COVER
2016+ RXV; 2017+ RXV ELITE; 2016+ 2FIVE

BAGWELL LINER



643973 RXV BAGWELL CLOSEOUT
2016+ RXV; 2017+ RXV ELITE; 2016+ 2FIVE

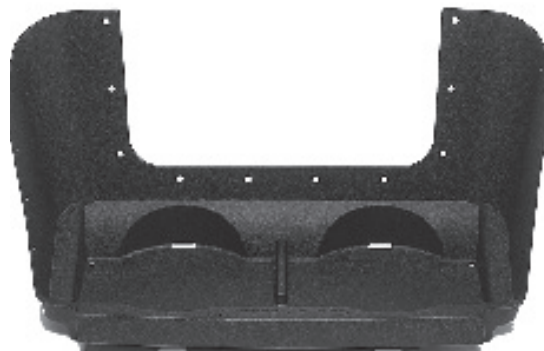

650254 BAGWELL LINER
2016+ RXV; 2017+ RXV ELITE; 2016+ 2FIVE

601679 BAGWELL LINER INSERT
2008-2015 RXV; 2010-2015 2FIVE

ACCELERATOR

AIR CLEANER

BATTERY &
CHARGER

BODY & TRIM

CLUTCHES

DIRECTION
SELECTOR

ELECTRIC
MOTOR

ELECTRICAL
SYSTEM

ENGINE
& MUFFLER

FRONT
SUSPENSION
& STEERING

FUEL SYSTEM

ON THE
COURSE

REAR AXLE

REAR
SUSPENSION

SEATING

SPECIALTY
TOOLS

TOPS,
WINDSHIELDS
& PROTECTION

RXV BODY & COWL

RXV 2008-2015
WITHOUT LIGHT CUT-OUTS

COLOR	BODY
FLAME RED	614984
BLACK	614981
SUNBURST ORANGE	617590
BRITISH RACING GREEN	617592
METALLIC CHARCOAL	630187
ALMOND	614988
FOREST GREEN	614979
PLATINUM	614989
STEEL BLUE	614985
PATRIOT BLUE	614980
BRIGHT WHITE	614983
IVORY	614976
JAVA BROWN	630207
INFERNO RED	614986
ELECTRIC BLUE	614987

COLOR	COWL
FLAME RED	645759G0039
BLACK	645759G0011
SUNBURST ORANGE	645759G0051
BRITISH RACING GREEN	645759G052
METALLIC CHARCOAL	645759G031
ALMOND	645759G0044
FOREST GREEN	645759G0037
PLATINUM	645759G0042
STEEL BLUE	645759G026
PATRIOT BLUE	645759G0019
BRIGHT WHITE	645759G038
IVORY	645759G0036
JAVA BROWN	645759G0076
INFERNO RED	645759G0020
ELECTRIC BLUE	645759G0041



2016-CURRENT

WITHOUT LIGHT CUT-OUTS

COLOR	BODY
FLAME RED	650353G0039
BLACK	650353G0011
SUNBURST ORANGE	650353G0051
BRITISH RACING GREEN	650353G0052
METALLIC CHARCOAL	650353G0031
ALMOND	650353G0044
FOREST GREEN	650353G0037
PLATINUM	650353G0042
STEEL BLUE	650353G0026
PATRIOT BLUE	650353G0019
BRIGHT WHITE	650353G0038
IVORY	650353G0036
JAVA BROWN	650353G0076
INFERNO RED	650353G0020
ELECTRIC BLUE	650353G0041

COLOR	COWL
FLAME RED	645759G0039
BLACK	645759G0011
SUNBURST ORANGE	654759G0051
BRITISH RACING GREEN	645759G0052
METALLIC CHARCOAL	645759G0031
ALMOND	645759G0044
FOREST GREEN	645759G0037
PLATINUM	645759G0042
STEEL BLUE	645759G0026
PATRIOT BLUE	645759G0019
BRIGHT WHITE	645759G0038
IVORY	645759G0036
JAVA BROWN	645759G0076
INFERNO RED	645759G0020
ELECTRIC BLUE	645759G0041



BUMPERS & BRUSH GUARDS



605935 FRONT BUMPER
2008-2015 RXV; 2010-2015 2FIVE

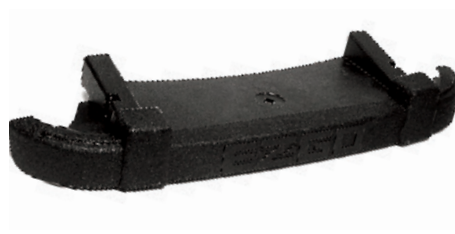

689702 REAR BUMPER ASSEMBLY
2016+ RXV; 2017+ RXV ELITE; 2016+ 2FIVE



641628 FRONT BUMPER BRACKET
2016+ RXV; 2017+ RXV ELITE



626455 MIRROR FINISH UPPER BRUSH GUARD
2009+ RXV; 2017+ RXV ELITE



626456 MIRROR FINISH LOWER BRUSH GUARD
2009+ RXV; 2017+ RXV ELITE

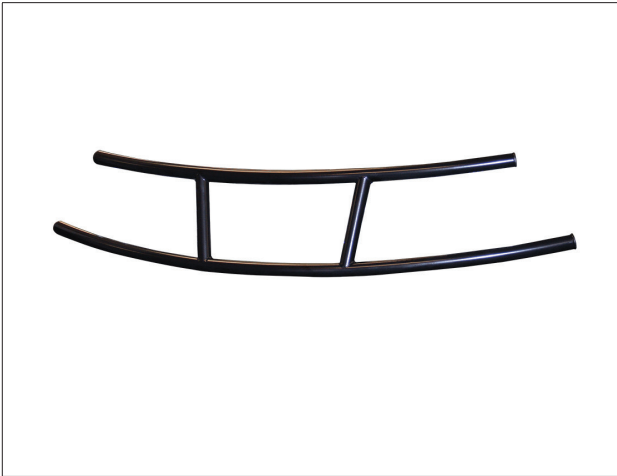

626459 BLACK UPPER BRUSH GUARD
2009+ RXV; 2017+ RXV ELITE



626460 BLACK LOWER BRUSH GUARD
2009+ RXV; 2017+ RXV ELITE



601621 DRIVERS SIDE REAR SPLASH GUARD
2008+ RXV; 2017+ RXV ELITE; 2010+ 2FIVE



601622 PASSENGERS SIDE REAR SPLASH GUARD
2008+ RXV; 2017+ RXV ELITE; 2010+ 2FIVE

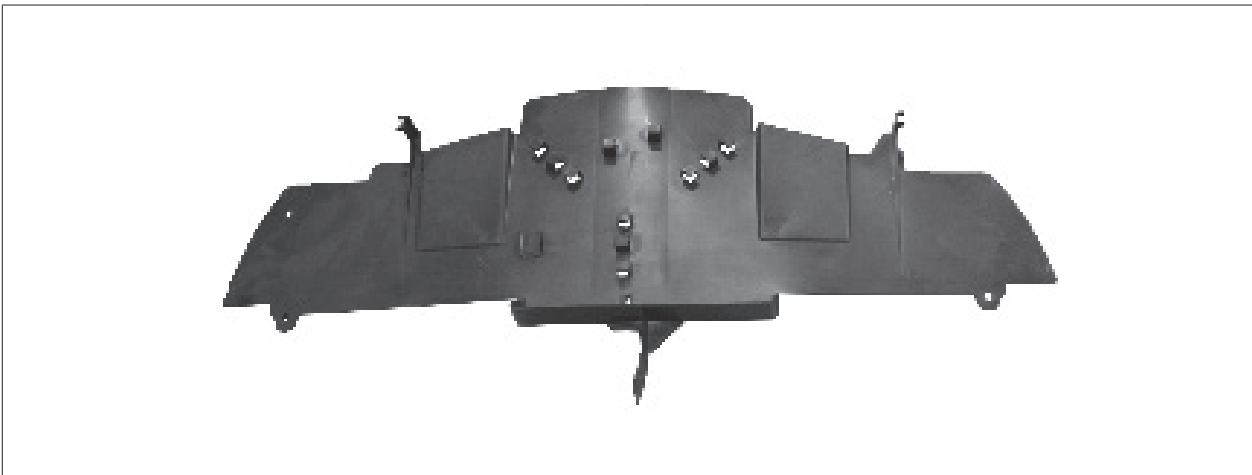

601634 FRONT SPLASH GUARD
2008+ RXV; 2017+ RXV ELITE; 2010+ 2FIVE

ACCELERATOR

AIR CLEANER

BATTERY &
CHARGER

BODY & TRIM

CLUTCHES

DIRECTION
SELECTOR

ELECTRIC
MOTOR

ELECTRICAL
SYSTEM

ENGINE
& MUFFLER

FRONT
SUSPENSION
& STEERING

FUEL SYSTEM

ON THE
COURSE

REAR AXLE

REAR
SUSPENSION

SEATING

SPECIALTY
TOOLS

TOPS,
WINDSHIELDS
& PROTECTION

FLOORMATS

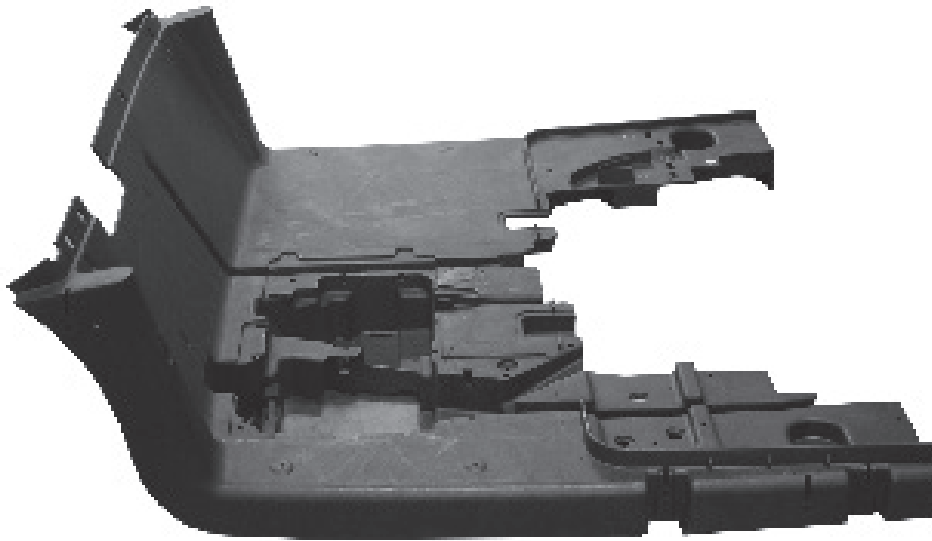

600225 FLOORBOARD
2008+ RXV; 2017+ RXV ELITE; 2010+ 2FIVE

642444G01 REAR FACING FLOORBOARD ASM
2008-2015 RXV

FRAMES

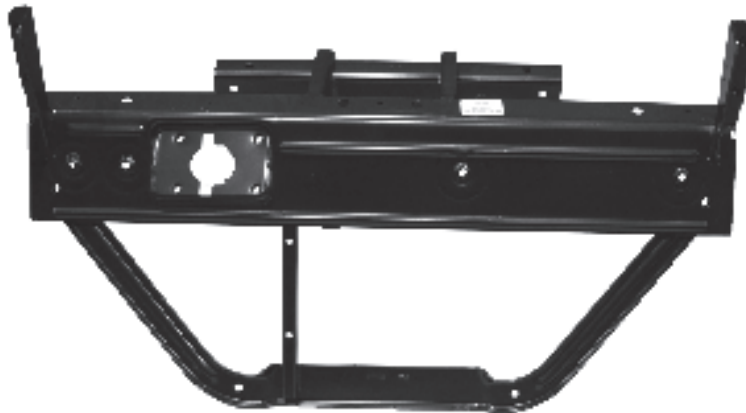

PART NUMBER	DESCRIPTION	VEHICLE
614597	INSTRUMENT PANEL SUPPORT WELDMENT	2009+ RXV; 2017+ RXV ELITE; 2010+ 2FIVE
657280G03	RXV FRAME WELDMENT - E-COAT/P-COAT	2016+ RXV; 2017+ RXV ELITE; 2016+ 2FIVE
657280G05	RXV FRAME WELDMENT - P-COAT ONLY	2016+ RXV; 2017+ RXV ELITE; 2016+ 2FIVE

FRONT SHIELDS



612104 FRONT FASCIA WITH LIGHTS
2010+ 2FIVE



656325 PREMIUM FRONT FASCIA
2016+ RXV; 2017+ RXV ELITE; 2016+ 2FIVE

GLOVE BOXES



PART NUMBER	DESCRIPTION	VEHICLE
607443	RXV GLOVE BOX KIT	2008+ RXV; 2017+ RXV ELITE; 2010+ 2FIVE
607131	RXV PASSENGERS SIDE GLOVE BOX ASSEMBLY	
607533	RXV DRIVERS SIDE GLOVE BOX ASSEMBLY	

INSTRUMENT PANEL



600242 INSTRUMENT PANEL TRIM
2008+ RXV; 2017+ RXV ELITE



602387 RXV INSTRUMENT PANEL ASSEMBLY
2008+ RXV; 2017+ RXV ELITE; 2010+ 2FIVE

ACCELERATOR

AIR CLEANER

BATTERY &
CHARGER

BODY & TRIM

CLUTCHES

DIRECTION
SELECTOR

ELECTRIC
MOTOR

ELECTRICAL
SYSTEM

ENGINE
& MUFFLER

FRONT
SUSPENSION
& STEERING

FUEL SYSTEM

ON THE
COURSE

REAR AXLE

REAR
SUSPENSION

SEATING

SPECIALTY
TOOLS

TOPS,
WINDSHIELDS
& PROTECTION

BODY & TRIM



608808 INSTRUMENT PANEL TRIM WITH KEY SWITCH/STATE OF CHARGE
2008+ RXV; 2017+ RXV ELITE

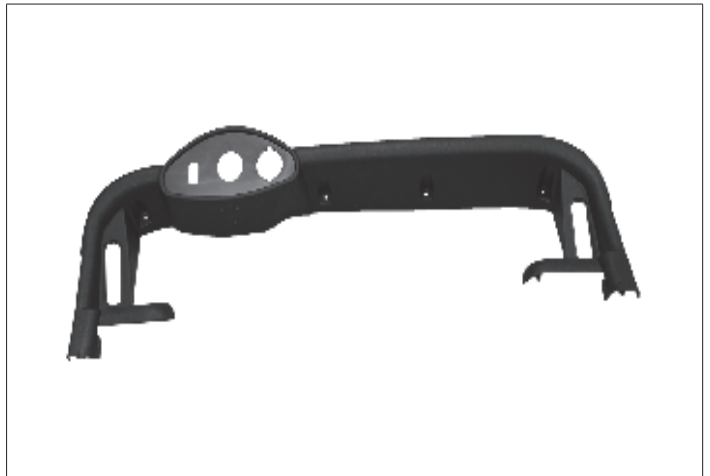

608864 INSTRUMENT PANEL TRIM
2008+ RXV; 2017+ RXV ELITE



645088 STRUT COVER
2009+ RXV; 2017+ RXV ELITE



602388 INSTRUMENT PANEL STRUT COVER ASSEMBLY
2008+ RXV; 2017+ RXV ELITE; 2010+ 2FIVE

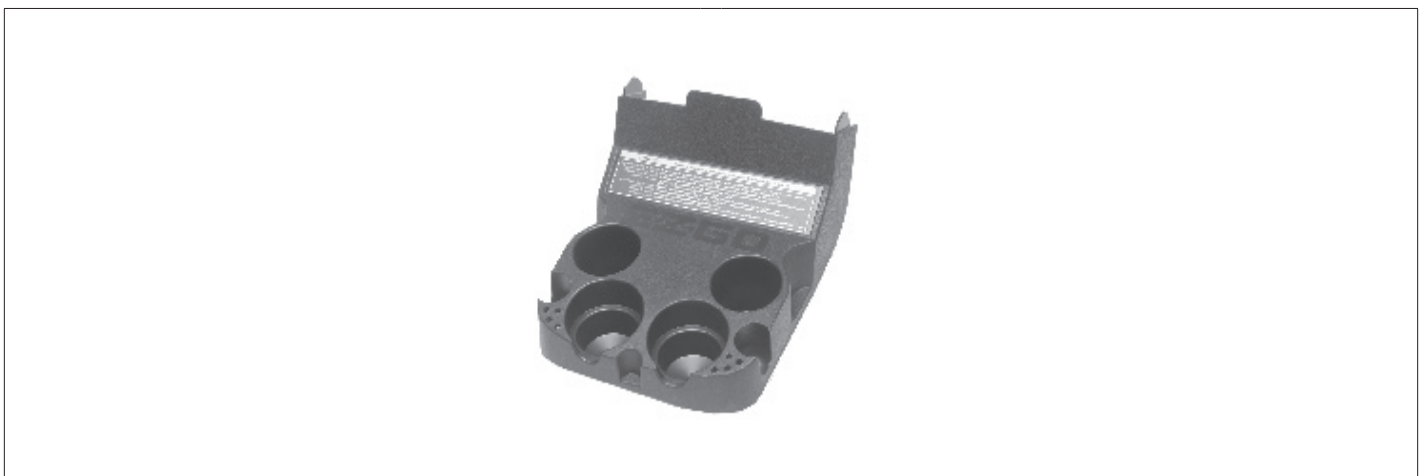

602101 CUP HOLDER ASSEMBLY
2008-2015 RXV

644117 CUP HOLDER ASSEMBLY
2016+ RXV; 2017+ RXV ELITE; 2016+ 2FIVE

MIRRORS



609388 SIDE VIEW MIRROR
2010-2015 2FIVE

670781 REARVIEW MIRROR WITH DISPLAY
2016+ 2FIVE

REFLECTORS



612776 RXV REFLECTOR KIT
2008+ RXV; 2017+ RXV ELITE; 2010+ 2FIVE

ROCKER PANELS & SILL PLATES



600257 PASSENGERS SIDE ROCKER PANEL

600253 DRIVERS SIDE ROCKER PANEL
2008+ RXV; 2017+ RXV ELITE; 2010+ 2FIVE

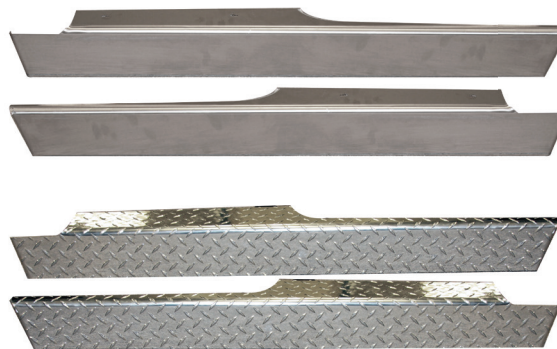

750481PKG RXV BRUSHED ROCKER SILLS PACKAGE

750482PKG RXV DIAMOND ROCKER SILLS PACKAGE
2008+ RXV



601258 PASSENGERS SIDE ROCKER PANEL

601257 DRIVERS SIDE ROCKER PANEL
2008+ RXV; 2017+ RXV ELITE; 2010+ 2FIVE



627401G01 RXV DRIVERS SIDE STRETCH ROCKER PANEL

627401G02 RXV PASSENGERS SIDE STRETCH ROCKER
PANEL
2009+ RXV

ACCELERATOR

AIR CLEANER

BATTERY &
CHARGER

BODY & TRIM

CLUTCHES

DIRECTION
SELECTOR

ELECTRIC
MOTOR

ELECTRICAL
SYSTEM

ENGINE
& MUFFLER

FRONT
SUSPENSION
& STEERING

FUEL SYSTEM

ON THE
COURSE

REAR AXLE

REAR
SUSPENSION

SEATING

SPECIALTY
TOOLS

TOPS,
WINDSHIELDS
& PROTECTION

SCUFF GUARDS



PART NUMBER	DESCRIPTION	VEHICLE
607441	RXV SCUFF GUARD KIT	2010-2015 2FIVE
601864	PASSENGERS SIDE SCUFF PAD	2008-2015 RXV; 2010-2015 2FIVE
601865	DRIVERS SIDE SCUFF PAD	
639807G01	DRIVERS SIDE SCUFF GUARD	2016+ RXV; 2017+ RXV ELITE
639807G02	PASSENGERS SIDE SCUFF GUARD	

STRETCH KITS



750773PKG 2009-2015 GAS RXV STRETCH PACKAGE
2009-2015 RXV

750772PKG RXV STRETCH KIT
2008+ RXV



CLUTCHES

SUB SECTION	PAGE
BELTS	116
DRIVE CLUTCHES	116
DRIVEN CLUTCHES	116
PACKAGES	117

CLUTCHES

BELTS



606138 STARTER BELT
2008+ RXV



618630 TEAM DRIVE BELT
2012+ RXV

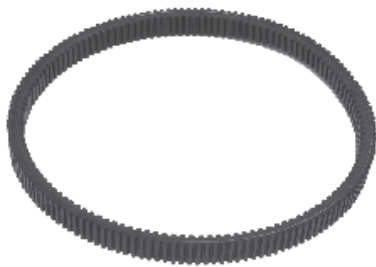

606136 DRIVE BELT
2008-2011 RXV

DRIVE CLUTCHES



672686 TEAM PRIMARY CLUTCH
2016+ RXV

DRIVEN CLUTCHES



644300 TEAM SECONDARY CLUTCH
2016+ RXV

PACKAGES



750410PKG KAWASAKI CLUTCH UPGRADE PACKAGE
2008+ RXV

ACCELERATOR

AIR CLEANER

BATTERY &
CHARGER

BODY & TRIM

CLUTCHES

DIRECTION
SELECTOR

ELECTRIC
MOTOR

ELECTRICAL
SYSTEM

ENGINE

FRONT
SUSPENSION
& STEERING

FUEL SYSTEM

ON THE
COURSE

REAR AXLE

REAR
SUSPENSION

SEATING

SPECIALTY
TOOLS

TOPS,
WINDSHIELDS
& PROTECTION



DIRECTION SELECTOR

SUB SECTION

PAGE

CABLES & LINKAGE

119

CABLES & LINKAGE

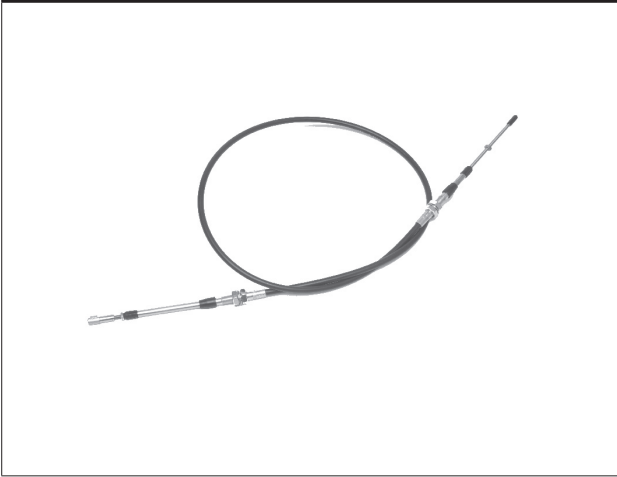

603615 SHORT WHEEL BASE FNR CABLE
2008+ RXV



71205G01 FNR HANDLE
2008+ RXV

ACCELERATOR

AIR CLEANER

BATTERY &
CHARGER

BODY & TRIM

CLUTCHES

**DIRECTION
SELECTOR**

ELECTRIC
MOTOR

ELECTRICAL
SYSTEM

ENGINE
& MUFFLER

FRONT
SUSPENSION
& STEERING

FUEL SYSTEM

ON THE
COURSE

REAR AXLE

REAR
SUSPENSION

SEATING

SPECIALTY
TOOLS

TOPS,
WINDSHIELDS
& PROTECTION



ELECTRIC MOTOR

SUB SECTION
MOTORS & COMPONENTS

PAGE
121

MOTORS & COMPONENTS



614252 RXV SPEED SENSOR KIT
2016+ RXV; 2016+ 2FIVE; 2017+ RXV ELITE



680638 48V AC ELECTRIC MOTOR
2016+ RXV; 2017+ RXV ELITE

ACCELERATOR

AIR CLEANER

BATTERY &
CHARGER

BODY & TRIM

CLUTCHES

DIRECTION
SELECTOR

**ELECTRIC
MOTOR**

ELECTRICAL
SYSTEM

ENGINE
& MUFFLER

FRONT
SUSPENSION
& STEERING

FUEL SYSTEM

ON THE
COURSE

REAR AXLE

REAR
SUSPENSION

SEATING

SPECIALTY
TOOLS

TOPS,
WINDSHIELDS
& PROTECTION



ELECTRICAL SYSTEM

SUB SECTION	PAGE
DC/DC CONVERTERS	123
FUSES, DIODES & RELAYS	123
GAUGES	123
HARNESSES	123-124
HORNS	124
IGNITION SWITCHES	124-125
LIGHTS	125-126
SOLENOIDS	126
SPEED CONTROLLER	127
TURN SIGNALS	128
VOLTAGE REGULATOR	128

DC/DC CONVERTERS



628607 RXV 20A DC-DC CONVERTER
RXV

FUSES, DIODES & RELAYS

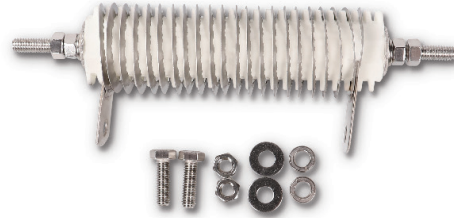

619001 .86 OHM RATED POWER RESISTOR
RXV; RXV ELITE

GAUGES



610583 FUEL/STATE OF CHARGE METER KIT
2009+ RXV; 2017+ RXV ELITE



612314 RXV FUEL/STATE OF CHARGE METER
2008+ RXV; 2017+ RXV ELITE



617074 HOUR METER
2016+ RXV

HARNESSES



614535 HARNESS ASSEMBLY W/ HEAVY DUTY
SOLENOID
2009-2015 RXV

ACCELERATOR

AIR CLEANER

BATTERY &
CHARGER

BODY & TRIM

CLUTCHES

DIRECTION
SELECTOR

ELECTRIC
MOTOR

**ELECTRICAL
SYSTEM**

ENGINE

FRONT
SUSPENSION
& STEERING

FUEL SYSTEM

ON THE
COURSE

REAR AXLE

REAR
SUSPENSION

SEATING

SPECIALTY
TOOLS

TOPS,
WINDSHIELDS
& PROTECTION

ELECTRICAL SYSTEM



PART NUMBER	DESCRIPTION	VEHICLE
631070	RXV HARNESS REPLACEMENT KIT	2009-2015 RXV
672891G01	HARNESS ASSEMBLY W/ HEAVY DUTY SOLENOID	
649816	RXV ELECTRIC ACCESSORY HARNESS	2016+ RXV; 2017+ RXV ELITE

HORNS

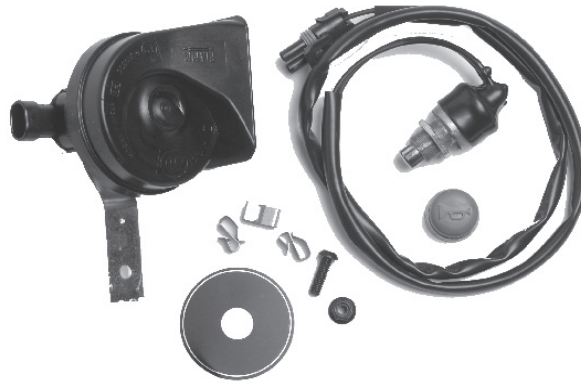

607528 RXV HORN ASSEMBLY KIT
RXV

IGNITION SWITCHES



611283 FNR SNAP-IN KEYSWITCH
2009+ RXV



611282 COMMON KEY SET ASSEMBLY
2016+ RXV; 2017+ RXV ELITE



609692 UNIQUE KEY AND KEY SWITCH SET
RXV; 2FIVE

LIGHTS



614009 RXV PTV KIT
2009-2015 RXV

649709 PTV KIT
2016+ RXV



627420 RXV ECONOMY LIGHT KIT
2009-2015 RXV



604511 TURN SIGNAL SWITCH SUB-ASSEMBLY
2008+ RXV; 2017+ RXV ELITE; 2010+ 2FIVE

ACCELERATOR

AIR CLEANER

BATTERY &
CHARGER

BODY & TRIM

CLUTCHES

DIRECTION
SELECTOR

ELECTRIC
MOTOR

**ELECTRICAL
SYSTEM**

ENGINE

FRONT
SUSPENSION
& STEERING

FUEL SYSTEM

ON THE
COURSE

REAR AXLE

REAR
SUSPENSION

SEATING

SPECIALTY
TOOLS

TOPS,
WINDSHIELDS
& PROTECTION

ELECTRICAL SYSTEM



607438 RXV RIGHT HAND HEAD LAMP ASSEMBLY
RXV; RXV ELITE; 2FIVE

607439 RXV LEFT HAND HEAD LAMP ASSEMBLY
RXV; RXV ELITE; 2FIVE



607450 RXV TAILLIGHT KIT
2009-2015 RXV



614009DELUXE RXV DELUXE PTV KIT
2009-2015 RXV

SOLENOIDS

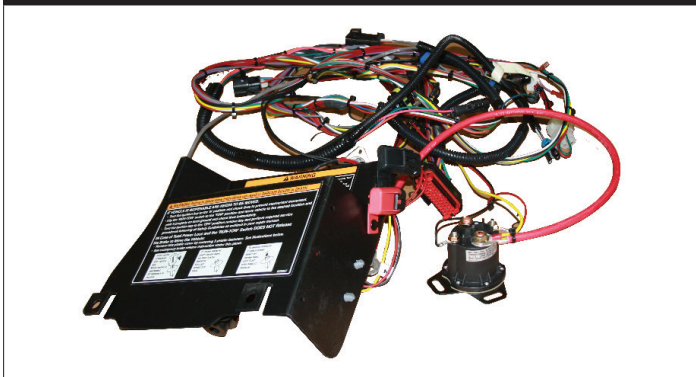

618955 ELECTRIC HARNESS ASSEMBLY W/ HD
SOLENOID
2009+ RXV



649240 48V SOLENOID
2016+ RXV; 2017+ RXV ELITE; 2016+ 2FIVE

SPEED CONTROLLER



649375



649385

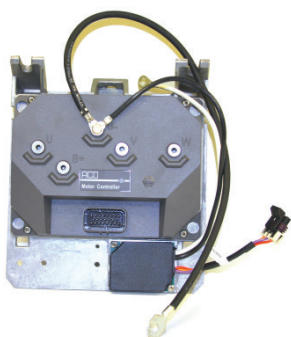

649546

PART NUMBER	DESCRIPTION	VEHICLE
649375	RXV 350A CONTROLLER	2008+ RXV
649376	350A RXV CONTROLLER KIT	
649382	1206AC CONTROLLER	
649383	206 AC CONTROLLER	
649384	1206AC CONTROLLER KIT	
649385	1206AC CONTROLLER KIT	
649546	1206AC 48V FREEDOM CONTROLLER KIT	
649547	206AC 48V FLEET CONTROLLER KIT	
667000G01	1206AC CONTROLLER	
667000G02	1206AC CONTROLLER	
653299	1206AC CONTROLLER	

ACCELERATOR

AIR CLEANER

BATTERY &
CHARGER

BODY & TRIM

CLUTCHES

DIRECTION
SELECTOR

ELECTRIC
MOTOR

**ELECTRICAL
SYSTEM**

ENGINE

FRONT
SUSPENSION
& STEERING

FUEL SYSTEM

ON THE
COURSE

REAR AXLE

REAR
SUSPENSION

SEATING

SPECIALTY
TOOLS

TOPS,
WINDSHIELDS
& PROTECTION

ELECTRICAL SYSTEM



PART NUMBER	DESCRIPTION	VEHICLE
750479PKG	AC CURTIS CONTROLLER PACKAGE	2008+ RXV
750891PKG	350A CURTIS CONTROLLER CONVERSION KIT	
750892PKG	350 CURTIS CONTROLLER CONVERSION	
750893PKG	350A DANAHER CONTROLLER CONVERSION	

TURN SIGNALS



607530 RXV TURN SIGNAL KIT

2008+ RXV

615236 TURN SIGNAL SWITCH ASSEMBLY W/ HORN

2010+ 2FIVE

VOLTAGE REGULATOR

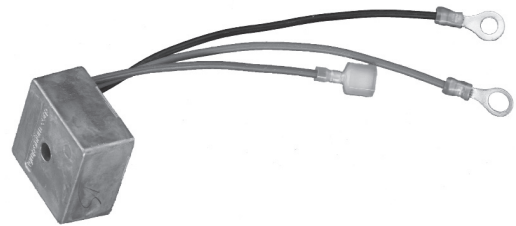

27739G01 VOLTAGE REGULATOR

2010+ 2FIVE



ENGINE

SUB SECTION	PAGE
AIR FILTER	130
BELTS	130
CARBURETOR & CHOKE	130
DIAGNOSTIC TOOL	130
ENGINE ASSEMBLY	131
ENGINE COMPONENTS	131-133
HOUSING & COMPONENTS	133
MUFFLER	134

ACCELERATOR

AIR CLEANER

BATTERY &
CHARGER

BODY & TRIM

CLUTCHES

DIRECTION
SELECTOR

ELECTRIC
MOTOR

ELECTRICAL
SYSTEM

ENGINE

FRONT
SUSPENSION
& STEERING

FUEL SYSTEM

ON THE
COURSE

REAR AXLE

REAR
SUSPENSION

SEATING

SPECIALTY
TOOLS

TOPS,
WINDSHIELDS
& PROTECTION

ENGINE

AIR FILTER

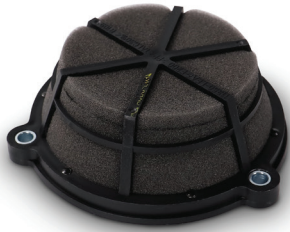

696008 EX1 AIR FILTER
2020+ VEHICLES WITH EX1 ENGINE



28463G01 AIR CLEANER ELEMENT
2008+ RXV

BELTS



696533 EX1 DRIVE BELT
2020+ VEHICLES WITH EX1 ENGINE

CARBURETOR & CHOKE



607955 NON-GOLF APPLICATION CARBURETOR
2008+ RXV
607954 GOLF APPLICATION CARBURETOR
2008+ RXV

DIAGNOSTIC TOOLS



10001280 EX1 DIAGNOSTIC TOOL
2020+ VEHICLES WITH EX1 ENGINE

ENGINE ASSEMBLY



689380 13HP ENGINE
2008+ RXV

ENGINE COMPONENTS



606067 ROLLOVER VALVE
2008+ RXV



606390 OIL DIPSTICK
2008+ RXV



607462 SPARK PLUG
2008+ RXV



696012 EX1 DIP STICK
2020+ VEHICLES WITH EX1 ENGINE

ACCELERATOR

AIR CLEANER

BATTERY &
CHARGER

BODY & TRIM

CLUTCHES

DIRECTION
SELECTOR

ELECTRIC
MOTOR

ELECTRICAL
SYSTEM

ENGINE

FRONT
SUSPENSION
& STEERING

FUEL SYSTEM

ON THE
COURSE

REAR AXLE

REAR
SUSPENSION

SEATING

SPECIALTY
TOOLS

TOPS,
WINDSHIELDS
& PROTECTION

ENGINE



680373 EX1 O2 SENSOR
2020+ VEHICLES WITH EX1 ENGINE



696497 EX1 SPARK PLUG
2020+ VEHICLES WITH EX1 ENGINE



684135 EX1 FUEL PUMP RELAY
2020+ VEHICLES WITH EX1 ENGINE



684128 EX1 ECU
2020+ VEHICLES WITH EX1 ENGINE



680387 EX1 ISG CONTROLLER
2020+ VEHICLES WITH EX1 ENGINE



680379 EX1 IGNITION COIL
2020+ VEHICLES WITH EX1 ENGINE



680380 EX1 THROTTLE BODY
2020+ VEHICLES WITH EX1 ENGINE



10001718 EX1 ECU BOOT
2020+ VEHICLES WITH EX1 ENGINE



696600 EX1 CVT SHOE
2020+ VEHICLES WITH EX1 ENGINE



696602 EX1 CVT SHOE SPRING
2020+ VEHICLES WITH EX1 ENGINE



696641 EX1 VAPOR HOSE
2020+ VEHICLES WITH EX1 ENGINE



28462G01 DUST EJECTOR VALVE
2008+ RXV

ACCELERATOR

AIR CLEANER

BATTERY &
CHARGER

BODY & TRIM

CLUTCHES

DIRECTION
SELECTOR

ELECTRIC
MOTOR

ELECTRICAL
SYSTEM

ENGINE

FRONT
SUSPENSION
& STEERING

FUEL SYSTEM

ON THE
COURSE

REAR AXLE

REAR
SUSPENSION

SEATING

SPECIALTY
TOOLS

TOPS,
WINDSHIELDS
& PROTECTION

HOUSING & COMPONENTS

MUFFLER



606982 EXHAUST PIPE HEADER
2008+ RXV



612266 KAWASAKI MUFFLER (SHOWN)
2008-03/14 RXV

630970 KAWASAKI MUFFLER
04/14 + RXV



607454 OIL FILTER
2008+ RXV



630587 STARTER GENERATOR BELT
2008+ RXV



631972 STARTER GENERATOR SUPPORT WELDMENT BRACKET
2014+ RXV

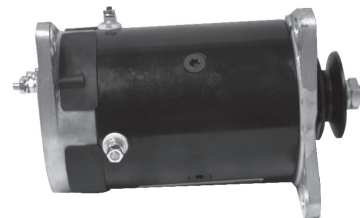

660379 STARTER GENERATOR
2008+ RXV



FRONT SUSPENSION & STEERING

SUB SECTION	PAGE
A-ARM ASM & SUSPENSION	136
SPINDLES & HUBS	136-137
STEERING COLUMNS & COMPONENTS	137
STEERING RACK & COMPONENTS	137-138

FRONT SUSPENSION & STEERING

A-ARM ASM & SUSPENSION



602085 A-ARM CARRIER TUBE
2008+ RXV; 2017+ RXV ELITE; 2010+ 2FIVE



608095 RXV A-ARM
2008+ RXV; 2017+ RXV ELITE; 2010+ 2FIVE

SPINDLES & HUBS



607413 LEFT HAND SPINDLE ASSEMBLY
2008+ RXV; 2017+ RXV ELITE



611271 RIGHT HAND SPINDLE ASSEMBLY
2008+ RXV; 2017+ RXV ELITE

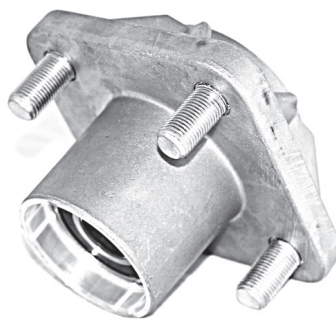

609603 RXV FRONT HUB ASSEMBLY
2008+ RXV; 2017+ RXV ELITE



614034 KINGPIN TUBE
2009+ RXV; 2017+ RXV ELITE; 2010+ 2FIVE

STEERING COLUMNS & COMPONENTS



604613 SUB-ASSEMBLY YOKE KIT
2008-2015 RXV

STEERING RACK & COMPONENTS



603297 TOW BAR TIE ROD
2008-2015 RXV



603322 LEFT HAND TIE ROD END
601266 RIGHT HAND TIE ROD END
2008-2015 RXV

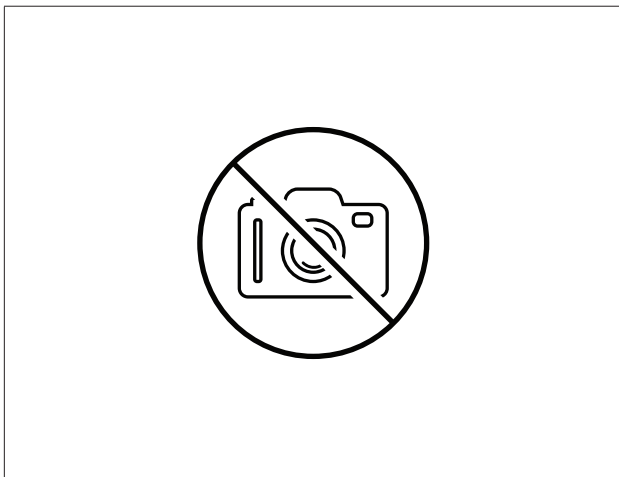

603816 BALL JOINT ROD ASSEMBLY
2016+ RXV



604614 RXV ROD END ASSEMBLY
2008-2015 RXV; 2010-2015 2FIVE

ACCELERATOR

AIR CLEANER

BATTERY &
CHARGER

BODY & TRIM

CLUTCHES

DIRECTION
SELECTOR

ELECTRIC
MOTOR

ELECTRICAL
SYSTEM

ENGINE

**FRONT
SUSPENSION
& STEERING**

FUEL SYSTEM

ON THE
COURSE

REAR AXLE

REAR
SUSPENSION

SEATING

SPECIALTY
TOOLS

TOPS,
WINDSHIELDS
& PROTECTION

FRONT SUSPENSION & STEERING



600333 STEERING COLUMN ASSEMBLY
2008+ RXV; 2017+ RXV ELITE; 2010+ 2FIVE



604615 RACK BOOT COVER KIT
2008-2015 RXV; 2010-2015 2FIVE



618329 STEERING RACK ASSEMBLY
2008+ RXV; 2017+ RXV ELITE



PART NUMBER	DESCRIPTION	VEHICLE
751263PKG	SHOCK ABSORBER SET	2016+ RXV; 2017+ RXV ELITE
663303	LEFT HAND SHOCK ABSORBER ASSEMBLY	2016+ RXV; 2017+ RXV ELITE
663321	RIGHT HAND SHOCK ABSORBER ASSEMBLY	2016+ RXV; 2017+ RXV ELITE
638948	RIGHT HAND SHOCK ABSORBER ASSEMBLY	2009-2015 RXV
655526	LEFT HAND STRUT ASSEMBLY	2016+ RXV; 2017+ RXV ELITE; 2016+ 2FIVE
655529	RIGHT HAND STRUT ASSEMBLY	



FUEL SYSTEM

SUB SECTION	PAGE
FUEL FILTERS	140
FUEL PUMPS	140

ACCELERATOR

AIR CLEANER

BATTERY &
CHARGER

BODY & TRIM

CLUTCHES

DIRECTION
SELECTOR

ELECTRIC
MOTOR

ELECTRICAL
SYSTEM

ENGINE

FRONT
SUSPENSION
& STEERING

FUEL SYSTEM

ON THE
COURSE

REAR AXLE

REAR
SUSPENSION

SEATING

SPECIALTY
TOOLS

TOPS,
WINDSHIELDS
& PROTECTION

FUEL FILTERS



72084G01 FUEL FILTER
2008+ RXV

FUEL PUMPS



602061 FUEL PUMP
2008+ RXV



ON THE COURSE

SUB SECTION	PAGE
BAG ATTACHMENTS	142
SAND BOTTLES & BUCKETS	142-143
TOW BAR	143

ACCELERATOR

AIR CLEANER

BATTERY &
CHARGER

BODY & TRIM

CLUTCHES

DIRECTION
SELECTOR

ELECTRIC
MOTOR

ELECTRICAL
SYSTEM

ENGINE

FRONT
SUSPENSION
& STEERING

FUEL SYSTEM

**ON THE
COURSE**

REAR AXLE

REAR
SUSPENSION

SEATING

SPECIALTY
TOOLS

TOPS,
WINDSHIELDS
& PROTECTION

BAG ATTACHMENTS

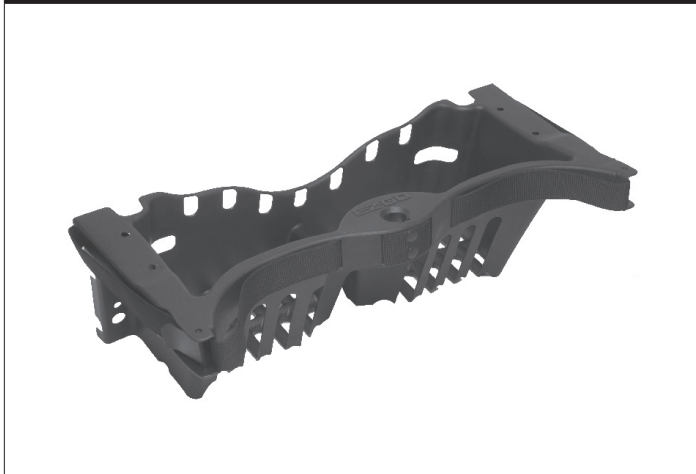

602742 SWEATER BASKET ASSEMBLY
2008+ RXV; 2017+ RXV ELITE; 2010+ 2FIVE



71853G01 BAG RETAINER STRAP
2008+ RXV; 2017+ RXV ELITE

COOLERS



689255 BEVERAGE COOLER KIT
2016+ RXV; 2017+ RXV ELITE; 2016+ 2FIVE

SAND BOTTLES & BUCKETS



689254 SAND BUCKET KIT
2016+ RXV; 2017+ RXV ELITE; 2016+ 2FIVE

662248 SAND BUCKET
2016+ RXV; 2017+ RXV ELITE; 2016+ 2FIVE



28659G01 SAND BOTTLE
2008+ RXV; 2017+ RXV ELITE; 2010+ 2FIVE



601624 TOW BAR STEERING LINK
2008-2015 RXV



646856 TOW BAR TIE ROD ASSEMBLY
2016+ RXV; 2017+ RXV ELITE

TOW BAR

ACCELERATOR

AIR CLEANER

BATTERY &
CHARGER

BODY & TRIM

CLUTCHES

DIRECTION
SELECTOR

ELECTRIC
MOTOR

ELECTRICAL
SYSTEM

ENGINE

FRONT
SUSPENSION
& STEERING

FUEL SYSTEM

**ON THE
COURSE**

REAR AXLE

REAR
SUSPENSION

SEATING

SPECIALTY
TOOLS

TOPS,
WINDSHIELDS
& PROTECTION



REAR AXLE

SUB SECTION	PAGE
AXLE ASSEMBLIES	145
REAR AXLE COMPONENTS	145-147

AXLE ASSEMBLIES



614063 14.76:1 AXLE
2008-2013 RXV; 2010+ 2FIVE
ENDS WITH SERIAL NUMBER 5303160



630901 16.99:1 ELECTRIC AXLE ASSEMBLY
2009+ RXV; 2017+ RXV ELITE
STARTED WITH SERIAL NUMBER 5303161

REAR AXLE COMPONENTS



614209 16.25 INCH RIGHT HAND AXLE SHAFT
2009+ RXV; 2017+ RXV ELITE

614208 24.75 INCH LEFT HAND REAR AXLE SHAFT
2009+ RXV; 2017+ RXV ELITE



614756 LIMITED SLIP DIFFERENTIAL KIT
2009+ RXV; 2017+ RXV ELITE; 2010+ 2FIVE

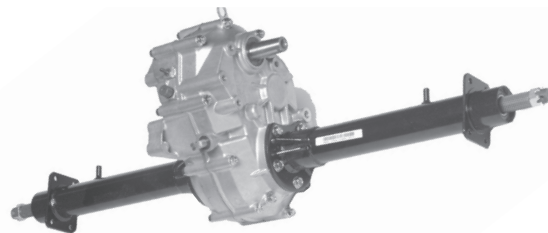

627891 GAS FUJI AXLE
2009-2015 RXV

ACCELERATOR

AIR CLEANER

BATTERY &
CHARGER

BODY & TRIM

CLUTCHES

DIRECTION
SELECTOR

ELECTRIC
MOTOR

ELECTRICAL
SYSTEM

ENGINE

FRONT
SUSPENSION
& STEERING

FUEL SYSTEM

ON THE
COURSE

REAR AXLE

REAR
SUSPENSION

SEATING

SPECIALTY
TOOLS

TOPS,
WINDSHIELDS
& PROTECTION

REAR AXLE



620327 INPUT GEAR
2009+ RXV; 2017+ RXV ELITE



620329 INPUT GEAR KIT
2009+ RXV; 2017+ RXV ELITE



620348 DIFFERENTIAL PLATE COVER
2009+ RXV; 2017+ RXV ELITE; 2016+ 2FIV



620349 INTERMEDIATE GEAR ASSEMBLY
2009+ RXV; 2017+ RXV ELITE



639876 LEFT HAND AXLE SHAFT
2009+ RXV

639881 RIGHT HAND AXLE SHAFT
2009+ RXV

ACCELERATOR

AIR CLEANER

BATTERY &
CHARGER

BODY & TRIM

CLUTCHES

DIRECTION
SELECTOR

ELECTRIC
MOTOR

ELECTRICAL
SYSTEM

ENGINE

FRONT
SUSPENSION
& STEERING

FUEL SYSTEM

ON THE
COURSE

REAR AXLE

REAR
SUSPENSION

SEATING

SPECIALTY
TOOLS

TOPS,
WINDSHIELDS
& PROTECTION



REAR SUSPENSION

SUB SECTION	PAGE
LEAF SPRINGS	149
MOUNTING PLATES & HARDWARE	149
SHOCK ABSORBERS	150

LEAF SPRINGS



604494 HEAVY DUTY TAPERED LEAF SPRING
2008+ RXV; 2017+ RXV ELITE; 2010+ 2FIVE



625709 MEDIUM DUTY TAPERED LEAF SPRING
2009+ RXV



624111 2.70 INCH BLACK/GREEN COMPRESSION SPRING
2009+ RXV

MOUNTING PLATES & HARDWARE



652245 SHACKLE PLATE
2008+ RXV; 2017+ RXV ELITE; 2010+ 2FIVE

ACCELERATOR

AIR CLEANER

BATTERY &
CHARGER

BODY & TRIM

CLUTCHES

DIRECTION
SELECTOR

ELECTRIC
MOTOR

ELECTRICAL
SYSTEM

ENGINE

FRONT
SUSPENSION
& STEERING

FUEL SYSTEM

ON THE
COURSE

REAR AXLE

**REAR
SUSPENSION**

SEATING

SPECIALTY
TOOLS

TOPS,
WINDSHIELDS
& PROTECTION

REAR SUSPENSION

SHOCK ABSORBERS



PART NUMBER	DESCRIPTION	VEHICLE
750117PKG	4 LEAF REAR SHOCK PACKAGE	2008+ RXV; 2017+ RXV ELITE
76418G01	SHOCK ABSORBER	2008+ RXV; 2017+ RXV ELITE; 2010+ 2FIVE



611724 REAR SHOCK ABSORBER
2009-2015 RXV; 2010-2015 2FIVE



SEATING

SUB SECTION	PAGE
HIP RESTRAINTS	152
SEAT BACKS	152
SEAT BOTTOMS	153
SEAT COVERS	154
SEAT PACKAGES	154
PREMIUM FRONT SEATS	154

HIP RESTRAINTS



607532 DRIVERS SIDE HIP RESTRAINT
2008-2015 RXV; 2010-2015 2FIVE

607653 PASSENGERS SIDE HIP RESTRAINT
2008-2015 RXV; 2010-2015 2FIVE



617644 PASSENGERS SIDE HIP RESTRAINT
2008+ RXV; 2017+ RXV ELITE; 2016+ 2FIVE

617645 DRIVERS SIDE HIP RESTRAINT
2008+ RXV; 2017+ RXV ELITE; 2016+ 2FIVE

SEAT BACKS



605548 STONE BEIGE SEAT BACK ASSEMBLY
2008-2015 RXV; 2010-2015 2FIVE

615133 BLACK SEAT BACK ASSEMBLY
2008-2015 RXV

SEAT BOTTOMS



COLOR	CONTOURED SEAT BACK ASM	CONTOURED SEAT BOTTOM
BLACK	641897G0006	629269G1506
STONE BEIGE	641897G0002	629269G1502
OYSTER	641897G0001	629269G1501
GRAY	641897G0004	629269G1504



PART NUMBER	DESCRIPTION	VEHICLE
629269G1002	STONE BEIGE SEAT BOTTOM ASSEMBLY	2008-2015 RXV
629269G1006	BLACK SEAT BOTTOM ASSEMBLY	
644819G02	STONE BEIGE SEAT BOTTOM	2016+ RXV

ACCELERATOR

AIR CLEANER

BATTERY &
CHARGER

BODY & TRIM

CLUTCHES

DIRECTION
SELECTOR

ELECTRIC
MOTOR

ELECTRICAL
SYSTEM

ENGINE

FRONT
SUSPENSION
& STEERING

FUEL SYSTEM

ON THE
COURSE

REAR AXLE

REAR
SUSPENSION

SEATING

SPECIALTY
TOOLS

TOPS,
WINDSHIELDS
& PROTECTION

SEATING

SEAT COVERS



PART NUMBER	DESCRIPTION	VEHICLE
600221	STONE BEIGE SEAT BOTTOM COVER	2008+ RXV; 2017+ RXV ELITE
615169	BLACK SEAT BOTTOM COVER	
608007	OYSTER SEAT BOTTOM COVER	
605537	STONE BEIGE SEAT BACK COVER	2008-2015 RXV; 2010-2015 2FIVE
615132	BLACK SEAT BACK COVER	2008-2015 RXV
PACKAGE		
750665PKG	BLACK SEAT BOTTOM AND BACK COVER PACKAGE	2008+ RXV; 2017+ RXV ELITE



605529 PLASTIC SEAT BACK COVER
2008+ RXV; 2017+ RXV ELITE; 2010+ 2FIVE

PREMIUM FRONT SEATS



COLOR	HIGH BACK	SEAT BOTTOM	VEHICLE
LIGHT BEIGE	647282G17	629269G1617	2008+ RXV; 2017+ RXV ELITE
MUSHROOM	647282G18	629269G1618	
BLACK	647282G21	629269G1621	



SPECIALTY TOOLS

SUB SECTION	PAGE
DIAGNOSTIC TOOLS	156

ACCELERATOR

AIR CLEANER

BATTERY &
CHARGER

BODY & TRIM

CLUTCHES

DIRECTION
SELECTOR

ELECTRIC
MOTOR

ELECTRICAL
SYSTEM

ENGINE

FRONT
SUSPENSION
& STEERING

FUEL SYSTEM

ON THE
COURSE

REAR AXLE

REAR
SUSPENSION

SEATING

**SPECIALTY
TOOLS**

TOPS,
WINDSHIELDS
& PROTECTION

DIAGNOSTIC TOOLS



664487 SAMSUNG SDI BATTERY DIAGNOSTIC TOOL
2017+ RXV ELITE



TOPS, WINDSHIELDS & PROTECTION

SUB SECTION	PAGE
54" TOP KITS	158
80" TOP KITS	159

ACCELERATOR

AIR CLEANER

BATTERY &
CHARGER

BODY & TRIM

CLUTCHES

DIRECTION
SELECTOR

ELECTRIC
MOTOR

ELECTRICAL
SYSTEM

ENGINE

FRONT
SUSPENSION
& STEERING

FUEL SYSTEM

ON THE
COURSE

REAR AXLE

REAR
SUSPENSION

SEATING

SPECIALTY
TOOLS

**TOPS,
WINDSHIELDS
& PROTECTION**

TOPS, WINDSHIELDS & PROTECTION



54" TOP KITS

For use with no rear seat or Factory Fixed/Flip Rear Seat

TOP KITS/TOPS/STRUTS				54" COMPATIBLE WINDSHIELDS		
TOP KIT	TOP	STRUTS	COLOR	606584 SPLIT/ CLEAR	611731 FLAT/ CLEAR	608767 SPLIT/TINTED
606354PKG	608198	620880	STONE BEIGE	X	X	X
608695PKG	608015	620880	OYSTER	X	X	X
613233	613227	620880	BLACK	X	X	X



ACCELERATOR

AIR CLEANER

BATTERY &
CHARGER

BODY & TRIM

CLUTCHES

DIRECTION
SELECTORELECTRIC
MOTORELECTRICAL
SYSTEM

ENGINE

FRONT
SUSPENSION
& STEERING

FUEL SYSTEM

ON THE
COURSE

REAR AXLE

REAR
SUSPENSION

SEATING

SPECIALTY
TOOLS**TOPS,
WINDSHIELDS
& PROTECTION**

80" TOP KITS

For use with Factory Fixed/Flip Seat

TOP KITS/TOPS/STRUTS			
TOP KIT	TOP	STRUTS	COLOR
610461	610434	603203/604423/604424	STONE BEIGE
610462	610433	603203/604423/604424	OYSTER
X	630309	603203/604423/604424	BLACK
X	687855	603203/604423/604424	GREY

80" COMPATIBLE WINDSHIELDS		
606584	611731	608767
SPLIT/CLEAR	FLAT/CLEAR	SPLIT/TINTED
X	X	X
X	X	X
X	X	X
X	X	X

80" TOP KITS

For use with Economy Flip Rear Seat

TOP KITS/TOPS/STRUTS			
TOP KIT	TOP	STRUTS	COLOR
614336	630307	614346/614347/614348	WHITE
614337	630308	614346/614347/614348	TAN
614338	630309	614346/614347/614348	BLACK
614344	PF10863	614346/614347/614348	STONE BEIGE

80" COMPATIBLE WINDSHIELDS		
606584	611731	608767
SPLIT/CLEAR	FLAT/CLEAR	SPLIT/TINTED
X	X	X
X	X	X
X	X	X
X	X	X

EXPRESS 2012- CURRENT





EXPRESS TABLE OF CONTENTS

Accelerator	16-17
Battery & Charger	18-25
Body & Trim	26-37
Clutches	38-40
Direction Selector	41-43
Electric Motor	44-46
Electrical System	47-53
Engine	54-62
Front Suspension & Steering	62-70
Fuel System	71-73
On the Course	74-75
Rear Axle	76-79
Rear Suspension	80-84
Seating	85-90
Specialty Tools	91-92
Tops, Windshields & Protection	93-95



ACCELERATOR

SUB SECTION
SWITCHES

PAGE
163

SWITCHES



25854G01 INDUCTIVE THROTTLE SENSOR
2014+ EXPRESS



25861G01 PEDALBOX MICROSWITCH
2012+ EXPRESS

ACCELERATOR

AIR CLEANER

BATTERY
& CHARGER

BODY & TRIM

CLUTCHES

DIRECTION
SELECTOR

ELECTRIC
MOTOR

ELECTRICAL
SYSTEM

ENGINE
& MUFFLER

FRONT
SUSPENSION
& STEERING

FUEL SYSTEM

REAR AXLE

REAR
SUSPENSION

SEATING

SPECIALTY
TOOLS

TOPS,
WINDSHIELDS
& PROTECTION



BATTERY & CHARGERS

SUB SECTION	PAGE
CABLES & WIRING	165
CHARGERS	165
HOLD DOWNS & STRAPS	166
LITHIUM	166

CABLES & WIRING



PART NUMBER	DESCRIPTION	VEHICLE
613236	6AWG 380MM BLUE WIRE ASSEMBLY	2012+ EXPRESS
613237	6AWG 150MM BLUE WIRE ASSEMBLY	
25971G18	4GA 6IN BLACK WIRE ASSEMBLY	
25971G13	4GA 10.5IN BLACK WIRE ASSEMBLY	

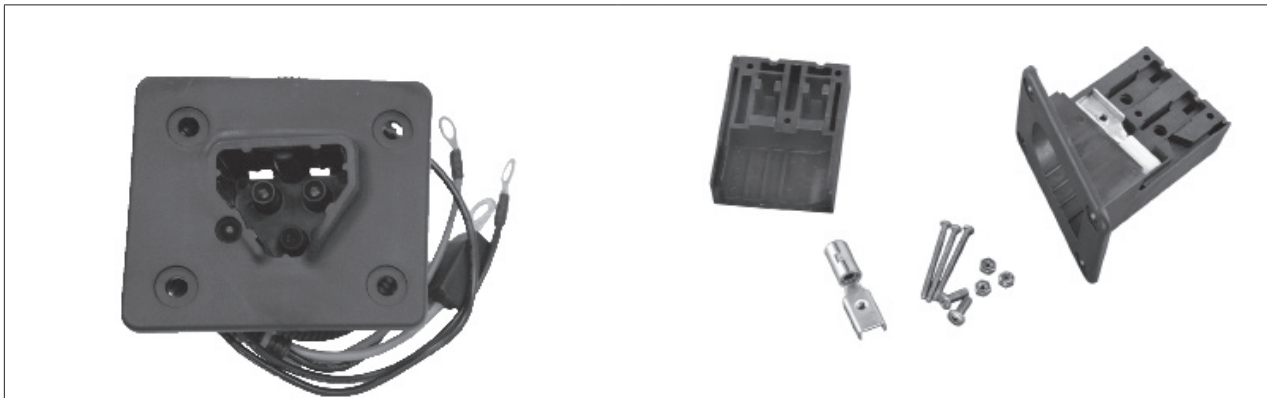

613304

73311G03

PART NUMBER	DESCRIPTION	VEHICLE
663285	48V CHARGER RECEPTACLE W/ HARNESS	2018+ EXPRESS
73311G03	72V CHARGER RECEPTACLE	2012+ EXPRESS
610536	ON-BOARD CHARGER RECEPTACLE	2018+ EXPRESS; TERRAIN 1000
613304	48V CHARGER RECEPTACLE	2012+ EXPRESS S4; 2010-2012 ST SPORT II; 2012-2016 SHUTTLE 4X; 2012-2016 TERRAIN 250

ACCELERATOR

AIR CLEANER

BATTERY & CHARGER

BODY & TRIM

CLUTCHES

DIRECTION SELECTOR

ELECTRIC MOTOR

ELECTRICAL SYSTEM

ENGINE & MUFFLER

FRONT SUSPENSION & STEERING

FUEL SYSTEM

REAR AXLE

REAR SUSPENSION

SEATING

SPECIALTY TOOLS

TOPS, WINDSHIELDS & PROTECTION

BATTERY & CHARGER

CHARGERS



622419



635671



653213

PART NUMBER	DESCRIPTION	VEHICLE
622419	48V WORLD CHARGER W/ 3M CORD	2012+ EXPRESS
635671	48V CHARGER W/ 3M CORD	2012+ EXPRESS; 2012+ SHUTTLE
653213	LITHIUM CHARGER W/ 3M CORD	2017+ EXPRESS ELITE
653214	LITHIUM CHARGER W/ 3M CORD	2017+ EXPRESS ELITE
634567	72V CHARGER W/ D-PLUG	2018+ EXPRESS; 2014-2016 TERRAIN 1000
640261	72V ON-BOARD CHARGER	2018+ EXPRESS

CORDS

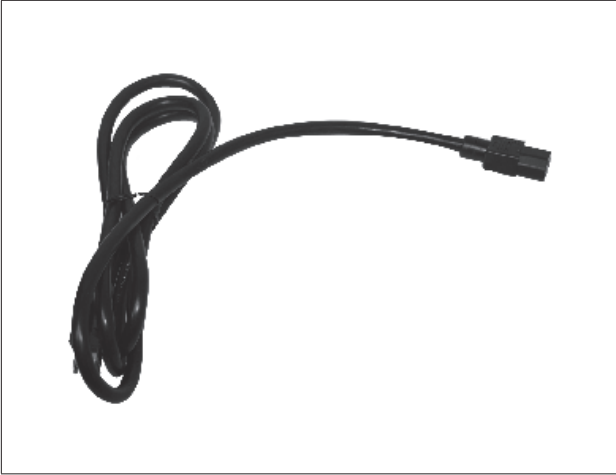

600462G01 AC CHARGER CORD
2012+ EXPRESS; 2005-2012 SHUTTLE; 2005-2012 ST EXPRESS

HOLD DOWNS & STRAPS



652254G03 BATTERY RACK
2012+ EXPRESS; 2012-2016 TERRAIN



612867 BATTERY RETAINER
22012+ EXPRESS

LITHIUM



696855 BATTERY MANAGEMENT SYSTEM
2017+ EXPRESS ELITE



665954 30AH CELL MODULE
2017+ EXPRESS ELITE

ACCELERATOR

AIR CLEANER

BATTERY & CHARGER

BODY & TRIM

CLUTCHES

DIRECTION SELECTOR

ELECTRIC MOTOR

ELECTRICAL SYSTEM

ENGINE & MUFFLER

FRONT SUSPENSION & STEERING

FUEL SYSTEM

REAR AXLE

REAR SUSPENSION

SEATING

SPECIALTY TOOLS

TOPS, WINDSHIELDS & PROTECTION



BODY & TRIM

SUB SECTION	PAGE
ACCESS PANEL	169
BAGWELL LINER	169
BUMPERS & BRUSHGUARDS	169-170
FLOOR MATS	170
BODY & COWLS	172-173
FRAMES	174
FRONT SHIELDS	174
GLOVE BOXES	175
INSTRUMENT PANEL	175-176
KICK PLATE	176
MIRRORS	176
NERF BAR	176
ROCKER PANELS & SILL PLATES	177
SCUFF GUARDS	177
SEAT PODS	178

ACCESS PANEL

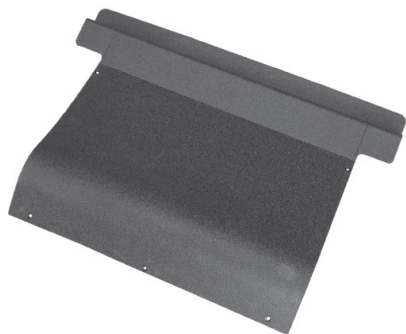

71320G01 BLACK ACCESS COVER
2012-2013 EXPRESS

BAGWELL LINER



624374 BAGWELL LINER
22012+ EXPRESS

ACCELERATOR

AIR CLEANER

BATTERY &
CHARGER

BODY & TRIM

CLUTCHES

DIRECTION
SELECTOR

ELECTRIC
MOTOR

ELECTRICAL
SYSTEM

ENGINE
& MUFFLER

FRONT
SUSPENSION
& STEERING

FUEL SYSTEM

REAR AXLE

REAR
SUSPENSION

SEATING

SPECIALTY
TOOLS

TOPS,
WINDSHIELDS
& PROTECTION

BUMPERS & BRUSHGUARDS

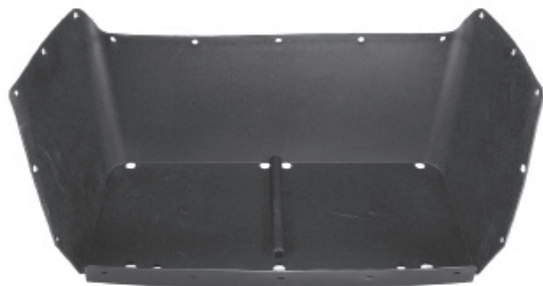

71318G01 BAGWELL LINER
2012-2013 EXPRESS



71456G01 REAR BUMPER
2012-2013 EXPRESS



643186 STAINLESS STEEL BRUSHGUARD
2012+ EXPRESS

617620 BRUSHGUARD
2012+ EXPRESS



664620 BRUSH GUARD WELDMENT
2018+ EXPRESS 4X4



750412PKG KW COWL BRUSHGUARD KIT
750592PKG KW STAINLESS STEEL BRUSHGUARD KIT
2012+ EXPRESS



627121 KW COWL FENDER FLARE KIT
2012+ EXPRESS



613274 PASSENGERS SIDE FENDER FLARE
614378 DRIVERS SIDE FRONT FENDER FLARE
2012+ EXPRESS; 2012-2016 TERRAIN

FENDER FLARES & MUD GUARDS



635054G01 DRIVERS SIDE FENDER LINER
2012+ EXPRESS

635054G02 PASSENGERS SIDE FENDER LINER
2012+ EXPRESS

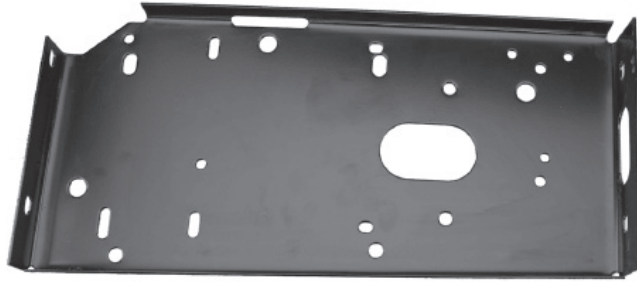

70244G05 PAINTED SPLASH PAN
2012+ EXPRESS

FLOORMAT

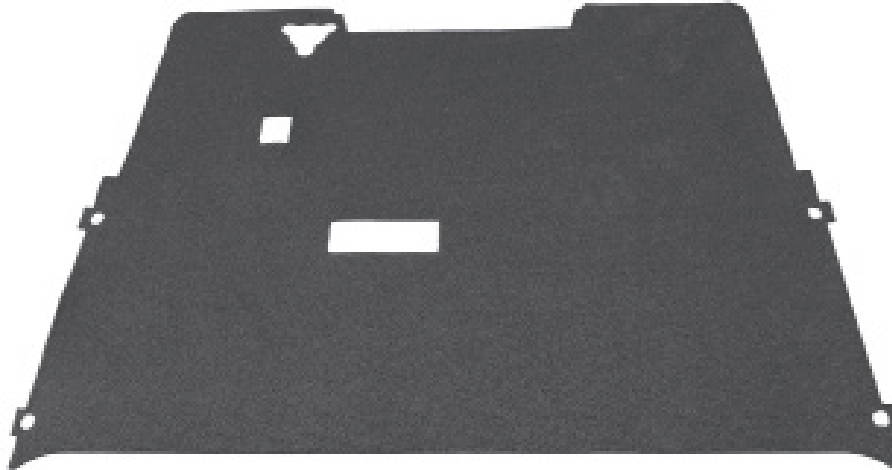

PART NUMBER	DESCRIPTION	VEHICLE
652139G03	FLOOR MAT WITH HORN HOLE	2012+ EXPRESS
637535G02	FLOOR MAT WITH HORN HOLE	2017+ EXPRESS
637535G01	FLOOR MAT	2017+ EXPRESS
70451G01	LOWER FLOORBOARD	2012+ EXPRESS

ACCELERATOR

AIR CLEANER

BATTERY &
CHARGER

BODY & TRIM

CLUTCHES

DIRECTION
SELECTOR

ELECTRIC
MOTOR

ELECTRICAL
SYSTEM

ENGINE
& MUFFLER

FRONT
SUSPENSION
& STEERING

FUEL SYSTEM

REAR AXLE

REAR
SUSPENSION

SEATING

SPECIALTY
TOOLS

TOPS,
WINDSHIELDS
& PROTECTION

EXPRESS/TERRAIN BODY & COWL

WITHOUT LIGHT CUT-OUTS

BODY

FLAME RED	625272G039
BLACK	625272G011
SUNBURST ORANGE	625272G051
OCEAN GREY	625272G0A5
ALMOND	625272G044
FOREST GREEN	625272G037
PLATINUM	625272G042
SAFETY YELLOW	625272G035
PATRIOT BLUE	625272G019
BRIGHT WHITE	625272G038
IVORY	625272G036
JAVA BROWN	625272G076
INFERNO RED	625272G020
ELECTRIC BLUE	625272G041
MONSTER GREEN	625272G069





COWL

FLAME RED	613036G039
BLACK	613036G011
SUNBURST ORANGE	613036G051
OCEAN GREY	613036G0A5
ALMOND	613036G044
FOREST GREEN	613036G037
PLATINUM	613036G042
SAFETY YELLOW	613036G035
PATRIOT BLUE	613036G019
BRIGHT WHITE	613036G038
IVORY	613036G036
JAVA BROWN	613036G076
INFERNO RED	613036G020
ELECTRIC BLUE	613036G041
MONSTER GREEN	613036G069

FRAMES



637378 FRONT POWERTRAIN FRAME WELDMENT
2018+ EXPRESS 4X4

FRONT SHIELDS



613273 FRONT FASCIA
2012+ EXPRESS; 2012-2016 TERRAIN



617643 COWL GRILL COVER
2012+ EXPRESS



618653 FRONT FASCIA BRACKET
2012+ EXPRESS



70725G02 FRONT SHIELD BRACE
22012+ EXPRESS

GLOVE BOXES



PART NUMBER	DESCRIPTION	VEHICLE
650784	PASSENGERS SIDE GLOVE BOX ASSEMBLY	2018+ EXPRESS 4X4
75459G01	GLOVE BOX ASSEMBLY	2012+ EXPRESS
75459G02	DRIVERS SIDE GLOVE BOX ASSEMBLY	
75459G03	PASSENGERS SIDE GLOVE BOX ASSEMBLY	

INSTRUMENT PANEL



71151G01 INSTRUMENT PANEL ASSEMBLY
2012-2013 EXPRESS



71151G03 INSTRUMENT PANEL ASSEMBLY
2012-2013 EXPRESS

ACCELERATOR

AIR CLEANER

BATTERY &
CHARGER

BODY & TRIM

CLUTCHES

DIRECTION
SELECTOR

ELECTRIC
MOTOR

ELECTRICAL
SYSTEM

ENGINE
& MUFFLER

FRONT
SUSPENSION
& STEERING

FUEL SYSTEM

REAR AXLE

REAR
SUSPENSION

SEATING

SPECIALTY
TOOLS

TOPS,
WINDSHIELDS
& PROTECTION

BODY & TRIM



71158G01 4 CUP INSTRUMENT PANEL INSERT
2012+ EXPRESS

KICK PLATE

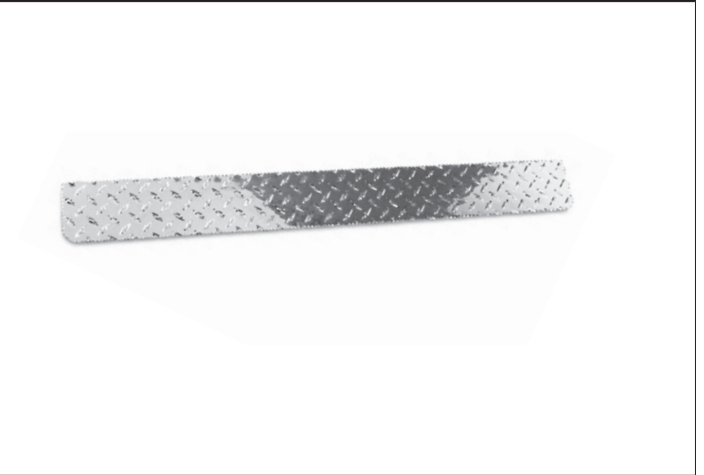

605393 KICK PLATE
2012+ EXPRESS



605394 BLACK KICK PLATE
2012+ EXPRESS

MIRROR



690087 REAR VIEW MIRROR
2012+ EXPRESS

NERF BAR



605386 BLACK NERF BAR
2012+ EXPRESS

ROCKER PANELS



617867/ 617870



618888/ 618889

PART NUMBER	DESCRIPTION	VEHICLE
617867	DRIVERS SIDE ROCKER PANEL	2012+ EXPRESS
617870	PASSENGERS SIDE ROCKER PANEL	
618888	PASSENGERS SIDE ROCKER PANEL	2012+ EXPRESS S4
618889	DRIVERS SIDE ROCKER PANEL	
639948G01	DRIVERS SIDE ROCKER PANEL	
639948G02	PASSENGERS SIDE ROCKER PANEL	

SCUFF GUARDS



PART NUMBER	DESCRIPTION	VEHICLE
625210	DRIVERS SIDE SCUFF PAD	2014+ EXPRESS
625211	PASSENGERS SIDE SCUFF PAD	



72763G02 SCUFF GUARD
2012+ EXPRESS

ACCELERATOR

AIR CLEANER

BATTERY &
CHARGER

BODY & TRIM

CLUTCHES

DIRECTION
SELECTOR

ELECTRIC
MOTOR

ELECTRICAL
SYSTEM

ENGINE
& MUFFLER

FRONT
SUSPENSION
& STEERING

FUEL SYSTEM

REAR AXLE

REAR
SUSPENSION

SEATING

SPECIALTY
TOOLS

TOPS,
WINDSHIELDS
& PROTECTION

SEAT PODS



PART NUMBER	DESCRIPTION	VEHICLE
648313G19	PATRIOT BLUE SEAT POD	2012+ EXPRESS
648313G20	INFERNO RED SEAT POD	
648313G36	IVORY BEIGE SEAT POD	
648313G37	HUNTER GREEN SEAT POD	
648313G38	BRIGHT WHITE SEAT POD	
648313G39	FLAME RED SET POD	



CLUTCHES

SUB SECTION	PAGE
BELTS	180
DRIVEN CLUTCHES	180

CLUTCHES

BELTS



618630 TEAM DRIVE BELT
2012+ EXPRESS

DRIVEN CLUTCHES



623949 TEAM SECONDARY CLUTCH
2012+ EXPRESS



DIRECTION SELECTOR

SUB SECTION	PAGE
CABLES & LINKAGE	182
DIRECTION SELECTOR ASSEMBLY	182

DIRECTION SELECTOR

CABLES & LINKAGE



605807 MEDIUM WHEELBASE FNR CABLE
2012+ EXPRESS



605809 LONG WHEELBASE FNR CABLE
2012+ EXPRESS



73049G01 FNR COVER
2012+ EXPRESS



71205G01 FNR HANDLE
2012+ EXPRESS

DIRECTION SELECTOR ASSEMBLY



74323G01 FNR SWITCH
2002-2012 ST EXPRESS; 2012-2016 TERRAIN



72400G01 MG5/SHUTTLE SHIFT CONTROL ASSEMBLY
1995-2008 SHUTTLE; 1995-2008 ST EXPRESS



ELECTRIC MOTOR

SUB SECTION
MOTORS & COMPONENTS

PAGE
184-185

ACCELERATOR

AIR CLEANER

BATTERY &
CHARGER

BODY & TRIM

CLUTCHES

DIRECTION
SELECTOR

**ELECTRIC
MOTOR**

ELECTRICAL
SYSTEM

ENGINE
& MUFFLER

FRONT
SUSPENSION
& STEERING

FUEL SYSTEM

REAR AXLE

REAR
SUSPENSION

SEATING

SPECIALTY
TOOLS

TOPS,
WINDSHIELDS
& PROTECTION

ELECTRIC MOTOR

MOTORS & COMPONENTS



628660 48V SE ELECTRIC MOTOR
2014+ EXPRESS



750440PKG 48V SE MOTOR PACKAGE
2012+ EXPRESS



624105 48V SC MOTOR
2012+ EXPRESS; 2012-2016 TERRAIN

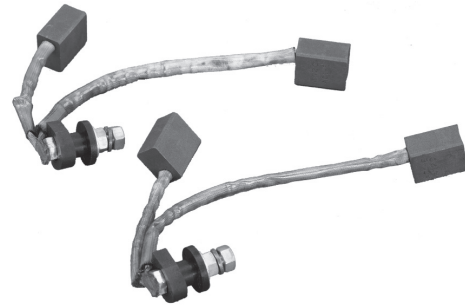

73120G25 BRUSH REPLACEMENT KIT
2012+ EXPRESS

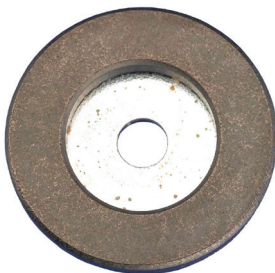

73328G01 PDS SPEED SENSOR MAGNET
2012+ EXPRESS



629410 48V 8 BRUSH MOTOR KIT
2014+ EXPRESS



PART NUMBER	DESCRIPTION	VEHICLE
671146	72V AC CLOCKED MOTOR KIT	2018+ EXPRESS 4X4
680639	72V AC CLOCKED MOTOR	
680638	48V AC ELECTRIC MOTOR	2018+ EXPRESS S4 ELITE

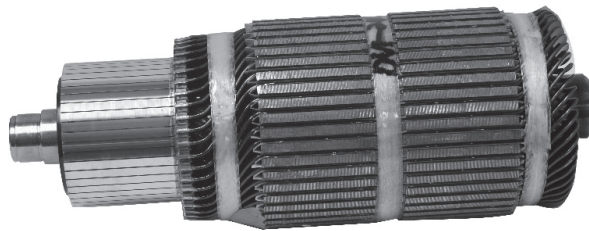

73120G36 ARMATURE ASSEMBLY
2012+ EXPRESS

ACCELERATOR

AIR CLEANER

BATTERY &
CHARGER

BODY & TRIM

CLUTCHES

DIRECTION
SELECTOR

**ELECTRIC
MOTOR**

ELECTRICAL
SYSTEM

ENGINE
& MUFFLER

FRONT
SUSPENSION
& STEERING

FUEL SYSTEM

REAR AXLE

REAR
SUSPENSION

SEATING

SPECIALTY
TOOLS

TOPS,
WINDSHIELDS
& PROTECTION



ELECTRICAL SYSTEM

SUB SECTION	PAGE
GAUGES	187
HARNESSES	188
IGNITION SWITCHES	188-189
LIGHTS	189-190
SOLENOIDS	190
SPEED CONTROLLER	190-191
SWITCHES	191
TURN SIGNALS	191
VOLTAGE REGULATOR	191

GAUGES



617074 HOUR METER
2018+ EXPRESS S4 ELITE; 2012+ EXPRESS



648247 FUEL GAUGE
2012+ EXPRESS

667014G01 SOC HOUR METER -GREEN BACK LIT
72V EXPRESS : LITHIUM EXPRESS



33636G05 48V VERTICAL STATE OF CHARGE METER
2012+ EXPRESS



750288PKG 48V VERTICAL STATE OF CHARGE METER PACKAGE
2012+ EXPRESS

ACCELERATOR

AIR CLEANER

BATTERY &
CHARGER

BODY & TRIM

CLUTCHES

DIRECTION
SELECTOR

ELECTRIC
MOTOR

**ELECTRICAL
SYSTEM**

ENGINE
& MUFFLER

FRONT
SUSPENSION
& STEERING

FUEL SYSTEM

REAR AXLE

REAR
SUSPENSION

SEATING

SPECIALTY
TOOLS

TOPS,
WINDSHIELDS
& PROTECTION

HARNESSES

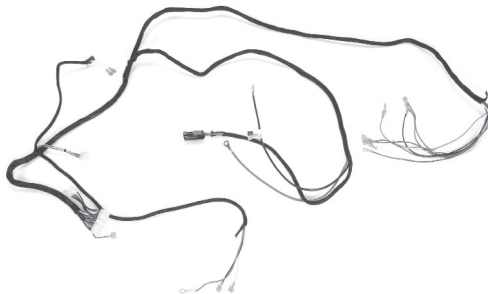

PART NUMBER	DESCRIPTION	VEHICLE
73334G01	PDS CONTROL WIRE HARNESS	2012 EXPRESS
74649G01	48VDC CONTROL HARNESS WIRE	2014+ EXPRESS
620418	48V PEDAL/ITS HARNESS	2012+ EXPRESS; 2012-2016 TERRAIN

IGNITION SWITCHES



611282 COMMON KEY SET ASSEMBLY
2018+ EXPRESS; 2018+ EXPRESS ELITE

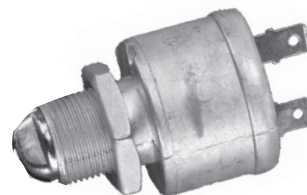

18602G1 IGNITION SWITCH
2012+ EXPRESS

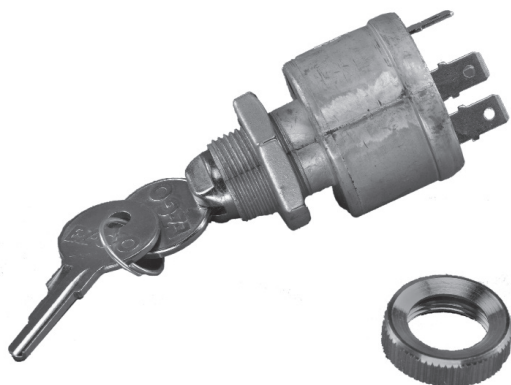

33639G01 STANDARD IGNITION SWITCH W/ LIGHTS
2012+ EXPRESS

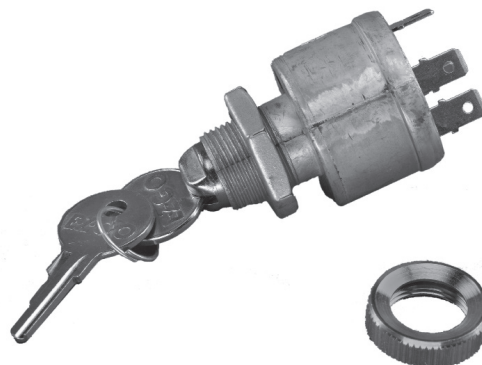

33639G02 NON-STANDARD IGNITION SWITCH W/ LIGHTS
2012+ EXPRESS

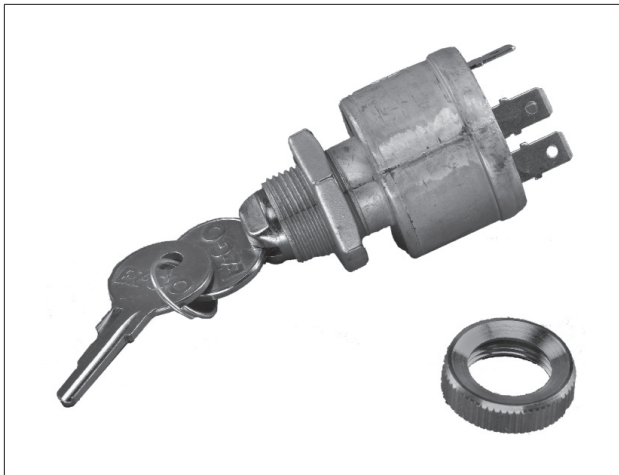

PART NUMBER	DESCRIPTION	VEHICLE
611283	FNR SNAP-IN KEYSWITCH	2018+ EXPRESS
653072	4 POSITION RNF SNAP IN KEYSWITCH	2012+ EXPRESS
655131	UNIQUE KEY SWITCH & KEY SET	2012+ EXPRESS S4 : L6
33639G03	INDIVIDUALLY KEYED IGNITION SWITCH W/ LIGHTS	2012+ EXPRESS

LIGHTS



PART NUMBER	DESCRIPTION	VEHICLE
627117	KW COWL STANDARD HEADLIGHT KIT	2012+ EXPRESS
644876	RIGHT HAND HEADLIGHT ASSEMBLY	2012+ EXPRESS; 2012-2016 TERRAIN
644877	LEFT HAND HEADLIGHT ASSEMBLY	
659008	RIGHT HAND LED HEADLIGHT ASSEMBLY	
659009	LEFT HAND LED HEADLIGHT ASSEMBLY	
627120	LED HEADLIGHT KIT W/OUT TURN SIGNAL	2012-2019 EXPRESS
619102	TURN SIGNAL BULB ASSEMBLY	EXPRESS

ACCELERATOR

AIR CLEANER

BATTERY & CHARGER

BODY & TRIM

CLUTCHES

DIRECTION SELECTOR

ELECTRIC MOTOR

ELECTRICAL SYSTEM

ENGINE & MUFFLER

FRONT SUSPENSION & STEERING

FUEL SYSTEM

REAR AXLE

REAR SUSPENSION

SEATING

SPECIALTY TOOLS

TOPS, WINDSHIELDS & PROTECTION

ELECTRICAL SYSTEM



22288G1 COMPLETE TAIL LIGHT ASSEMBLY
2012+ EXPRESS



622712 TURN SIGNAL FIELD KIT
2012+ EXPRESS

SOLENOIDS



PART NUMBER	DESCRIPTION	VEHICLE
692030	72V SOLENOID	2012-2014 EXPRESS
672557	48V DC SOLENOID	

SPEED CONTROLLER



615551 1268 PDS CONTROLLER KIT
2012+ EXPRESS; 2012-2016 TERRAIN

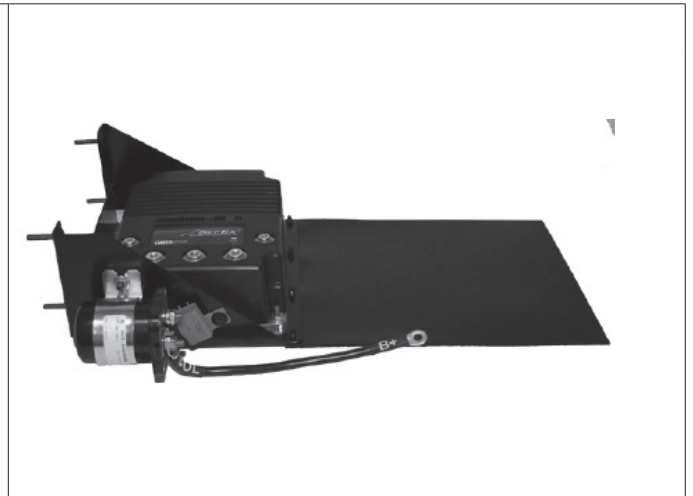

73348G04 1268 PDS CONTROLLER
2012+ EXPRESS



612632 48V CONTROLLER
 2012+ EXPRESS S4; 2010-2012 ST SPORT II; 2012-2016 SHUTTLE 4X; 2012-2016 TERRAIN 250

SPEED CONTROLLER COMPONENTS



620422 48V SPEED SENSOR HARNESS
 2012+ EXPRESS; 2012-2016 TERRAIN

SWITCHES



633114 RUN/TOW TOGGLE SWITCH
 2012+ EXPRESS

TURN SIGNALS



615236 TURN SIGNAL SWITCH ASSEMBLY W/ HORN
 2017+ EXPRESS

VOLTAGE REGULATOR

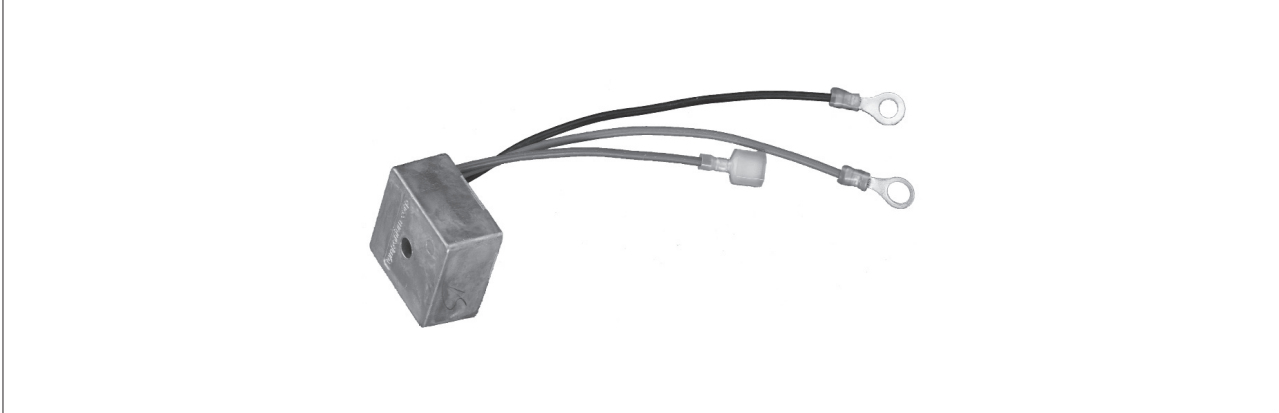

27739G01 VOLTAGE REGULATOR
 2012+ EXPRESS

ACCELERATOR

AIR CLEANER

BATTERY & CHARGER

BODY & TRIM

CLUTCHES

DIRECTION SELECTOR

ELECTRIC MOTOR

ELECTRICAL SYSTEM

ENGINE & MUFFLER

FRONT SUSPENSION & STEERING

FUEL SYSTEM

REAR AXLE

REAR SUSPENSION

SEATING

SPECIALTY TOOLS

TOPS, WINDSHIELDS & PROTECTION



ENGINE

SUB SECTION	PAGE
CARBURETOR & CHOKE	193
ENGINE ASSEMBLY	193
ENGINE COMPONENTS	193-194
MUFFLER	194
OIL FILTERS	194
STARTER GENERATOR	194-195

CARBURETOR & CHOKE

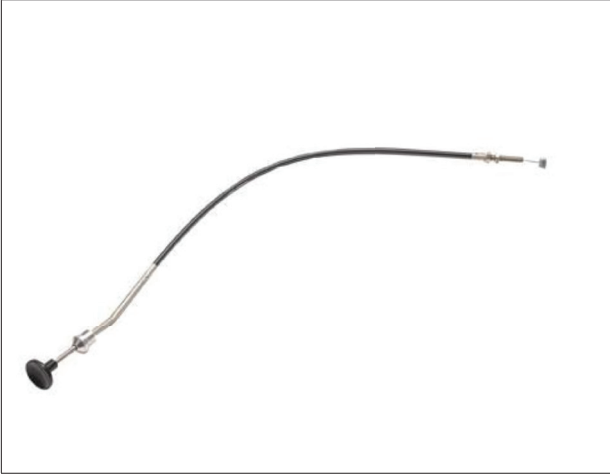

605868 CHOKE CABLE ASSEMBLY
2012+ EXPRESS



607955 NON-GOLF APPLICATION CARBURETOR
2012+ EXPRESS

ENGINE ASSEMBLY

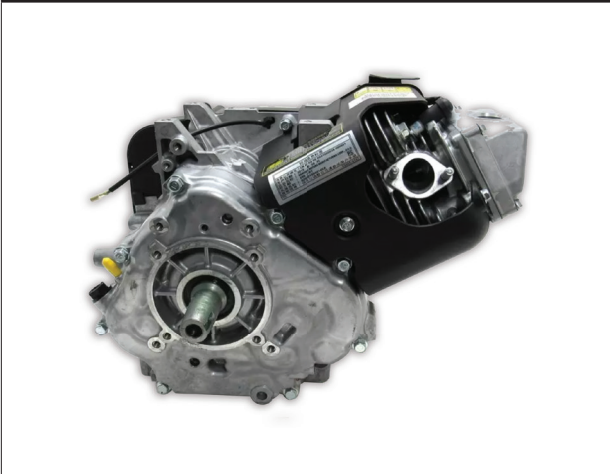

689380 13HP ENGINE
2012+ EXPRESS

ENGINE COMPONENTS



606067 ROLLOVER VALVE
2012+ EXPRESS



606390 OIL DIPSTICK
2012+ EXPRESS



607462 SPARK PLUG
2012+ EXPRESS

ACCELERATOR

AIR CLEANER

BATTERY &
CHARGER

BODY & TRIM

CLUTCHES

DIRECTION
SELECTOR

ELECTRIC
MOTOR

ELECTRICAL
SYSTEM

ENGINE

FRONT
SUSPENSION
& STEERING

FUEL SYSTEM

REAR AXLE

REAR
SUSPENSION

SEATING

SPECIALTY
TOOLS

TOPS,
WINDSHIELDS
& PROTECTION

ENGINE



606391 HIGH SUSPENSION OIL DIPSTICK
2012+ EXPRESS

MUFFLER



606982 EXHAUST PIPE HEADER
2012+ EXPRESS



630970 KAWASAKI MUFFLER
3/2014+ EXPRESS



70694G01 INNER ROD END
2012+ EXPRESS

OIL FILTER



607454 OIL FILTER
2012+ EXPRESS

STARTER GENERATOR



630587 STARTER GENERATOR BELT
2012+ EXPRESS



631972 STARTER GENERATOR SUPPORT WELDMENT BRACKET
2012+ EXPRESS



660379 STARTER GENERATOR
2012+ EXPRESS

ACCELERATOR

AIR CLEANER

BATTERY &
CHARGER

BODY & TRIM

CLUTCHES

DIRECTION
SELECTOR

ELECTRIC
MOTOR

ELECTRICAL
SYSTEM

ENGINE

FRONT
SUSPENSION
& STEERING

FUEL SYSTEM

REAR AXLE

REAR
SUSPENSION

SEATING

SPECIALTY
TOOLS

TOPS,
WINDSHIELDS
& PROTECTION



FRONT SUSPENSION & STEERING

SUB SECTION	PAGE
A-ARM ASM & SUSPENSION	197
FRONT AXLE	197
LEAF SPRINGS	197
SPINDLES & HUBS	198
STEERING COLUMNS & COMPONENTS	199-200
STEERING WHEEL	201
TIRE RODS	201

A-ARM ASM & SUSPENSION



638383G01 A-ARM WELDMENT
2018+ EXPRESS 4X4



638383G02 A-ARM W/ SWAY BAR BRACKET
2018+ EXPRESS 4X4

ACCELERATOR

AIR CLEANER

BATTERY &
CHARGER

BODY & TRIM

CLUTCHES

DIRECTION
SELECTOR

ELECTRIC
MOTOR

ELECTRICAL
SYSTEM

ENGINE

**FRONT
SUSPENSION
& STEERING**

FUEL SYSTEM

REAR AXLE

REAR
SUSPENSION

SEATING

SPECIALTY
TOOLS

TOPS,
WINDSHIELDS
& PROTECTION

FRONT AXLE



602512 FRONT AXLE WELDMENT
2012+ EXPRESS; 2012-2016 TERRAIN



640501G01 LEFT HAND FRONT STRUT ASSEMBLY
640501G04 RIGHT HAND REAR STRUT ASSEMBLY
2018+ EXPRESS 4X4

LEAF SPRINGS



PART NUMBER	DESCRIPTION	VEHICLE
70664G03	185 SILVER FRONT SPRING	2012+ EXPRESS
70989G03	150 PINK FRONT LEAF SPRING	

FRONT SUSPENSION & STEERING

SPINDLES & HUBS

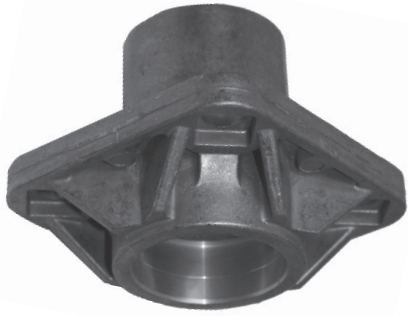

70589G01 WHEEL HUB
2012+ EXPRESS L6

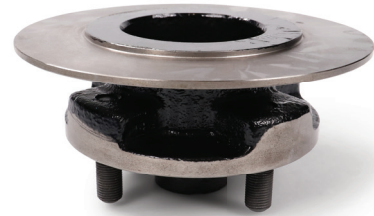

617121 REAR HUB ASSEMBLY
2018+ EXPRESS



PART NUMBER	DESCRIPTION	VEHICLE
602281	LEFT HAND SPINDLE ASSEMBLY	2012+ EXPRESS L6, S6
602288	RIGHT HAND SPINDLE ASSEMBLY	
602176	LEFT HAND MACHINED SPINDLE	
602158	RIGHT HAND MACHINED SPINDLE	
70931G02	LEFT HAND SPINDLE ASSEMBLY	2012+ EXPRESS S4
70930G02	RIGHT HAND SPINDLE ASSEMBLY	
70931G01	LEFT HAND SPINDLE ASSEMBLY	2012+ EXPRESS L6
70930G01	RIGHT HAND SPINDLE ASSEMBLY	
70803G01	LEFT HAND MACHINED SPINDLE	2012+ EXPRESS S4, L6, S6
70802G01	RIGHT HAND MACHINED SPINDLE	
70673G03	LEFT HAND SPINDLE ASSEMBLY	
70942G03	RIGHT HAND SPINDLE ASSEMBLY	

STEERING COLUMNS & COMPONENTS



70580G01 INTERMEDIATE SHAFT ASSEMBLY
2012+ EXPRESS



70607G01 STEERING SHAFT
2012+ EXPRESS



70610G03 STEERING COLUMN ASSEMBLY
2012+ EXPRESS



70997G01 STEERING COLUMN BASE COVER
2012+ EXPRESS



70758G05 STEERING COLUMN ASSEMBLY
2012+ EXPRESS

STEERING RACKS & COMPONENTS



600333 STEERING COLUMN ASSEMBLY
2018+ EXPRESS 4X4

ACCELERATOR

AIR CLEANER

BATTERY &
CHARGER

BODY & TRIM

CLUTCHES

DIRECTION
SELECTOR

ELECTRIC
MOTOR

ELECTRICAL
SYSTEM

ENGINE

**FRONT
SUSPENSION
& STEERING**

FUEL SYSTEM

REAR AXLE

REAR
SUSPENSION

SEATING

SPECIALTY
TOOLS

TOPS,
WINDSHIELDS
& PROTECTION

FRONT SUSPENSION & STEERING



70603G01 PINION
2012+ EXPRESS



70604G01 RACK
2012+ EXPRESS



70961G01 RACK BELLOWS COVER
2012+ EXPRESS



70964G01 STEERING BOX ASSEMBLY
2012+ EXPRESS



70965G01 STEERING RACK COVER W/ BEARING
2012+ EXPRESS



74605G01 STEERING BOX ASSEMBLY
2012+ EXPRESS

STEERING WHEEL



639439 VIPER STEERING WHEEL COVER
2018+ EXPRESS 4X4

TIE RODS



70897G02 24 INCH THREADED TIE ROD
2012+ EXPRESS

74730G01 15.15 INCH FOUR LINK ROD ASSEMBLY
2012+ EXPRESS



70876G02 26.44 INCH TIE ROD ASSEMBLY
2012+ EXPRESS



70904G06 10.91 INCH TIE ROD ASSEMBLY
2018+ EXPRESS 4X4



70902G01 LEFT HAND TIE ROD END
70902G02 RIGHT HAND TIE ROD END
2012+ EXPRESS



74604G01 TIE ROD ASSEMBLY
2012+ EXPRESS

ACCELERATOR

AIR CLEANER

BATTERY &
CHARGER

BODY & TRIM

CLUTCHES

DIRECTION
SELECTOR

ELECTRIC
MOTOR

ELECTRICAL
SYSTEM

ENGINE

**FRONT
SUSPENSION
& STEERING**

FUEL SYSTEM

REAR AXLE

REAR
SUSPENSION

SEATING

SPECIALTY
TOOLS

TOPS,
WINDSHIELDS
& PROTECTION



FUEL SYSTEM

SUB SECTION	PAGE
FUEL FILTERS	203
FUEL PUMPS	203
FUEL TANKS	203
SENDING UNITS	203
SIPHON TUBES	203

FUEL FILTERS



72084G01 FUEL FILTER
2012+ EXPRESS

FUEL PUMPS



602061 FUEL PUMP
2012+ EXPRESS

FUEL TANKS

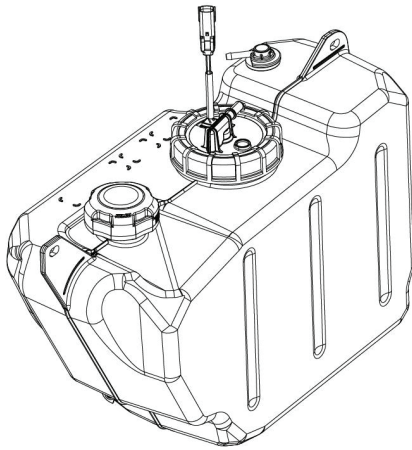

656139 FUEL TANK WITH SENDER ASSEMBLY
2012+ EXPRESS

SENDING UNITS



656144 FUEL PICKUP WITH SENDER
2012+ EXPRESS



20048G2 FUEL LEVEL SENDER
2012+ EXPRESS

SIPHON TUBES



18287G3 SIPHON TUBE ASSEMBLY
2012+ EXPRESS

ACCELERATOR

AIR CLEANER

BATTERY &
CHARGER

BODY & TRIM

CLUTCHES

DIRECTION
SELECTOR

ELECTRIC
MOTOR

ELECTRICAL
SYSTEM

ENGINE

FRONT
SUSPENSION
& STEERING

FUEL SYSTEM

REAR AXLE

REAR
SUSPENSION

SEATING

SPECIALTY
TOOLS

TOPS,
WINDSHIELDS
& PROTECTION



REAR AXLE

SUB SECTION	PAGE
AXLE ASSEMBLIES	205
REAR AXLE ASM	205
REAR AXLE COMPONENTS	206-207

AXLE ASSEMBLIES



PART NUMBER	DESCRIPTION	VEHICLE
670468	11.47:1 FUJI GAS AXLE	2012+ EXPRESS
670470	11.47:1 FUJI GAS AXLE WITH LIMITED SLIP DIFFERENTIAL	

REAR AXLE ASM



PART NUMBER	DESCRIPTION	VEHICLE
633599	16.99:1 AC ELECTRIC REAR AXLE	2018+ EXPRESS
633600	16.99:1 AC ELECTRIC REAR AXLE	
74612G01	14.76:1 ELECTRIC REAR AXLE	2012+ EXPRESS

ACCELERATOR

AIR CLEANER

BATTERY &
CHARGER

BODY & TRIM

CLUTCHES

DIRECTION
SELECTOR

ELECTRIC
MOTOR

ELECTRICAL
SYSTEM

ENGINE

FRONT
SUSPENSION
& STEERING

FUEL SYSTEM

REAR AXLE

REAR
SUSPENSION

SEATING

SPECIALTY
TOOLS

TOPS,
WINDSHIELDS
& PROTECTION

REAR AXLE

REAR AXLE COMPONENTS



620327 INPUT GEAR
2012+ EXPRESS



620329 INPUT GEAR KIT
2012+ EXPRESS



620348 DIFFERENTIAL PLATE COVER
2012+ EXPRESS



620349 INTERMEDIATE GEAR ASSEMBLY
2012+ EXPRESS

629151 INDEPENDENT DIFFERENTIAL HARDENED GEARS
2018+ EXPRESS 4X4



601085 DIFFERENTIAL COVER W/ PLUG
2012+ EXPRESS



50641G1 RUBBER BOOT
2012+ EXPRESS



612823 CARRIER COVER
2012+ EXPRESS



73050G01 DANA AXLE PUSH IN VENT ASSEMBLY
2012+ EXPRESS



PART NUMBER	DESCRIPTION	VEHICLE
639876	LEFT HAND AXLE SHAFT	2012+ EXPRESS S4, L6, S6
639881	RIGHT HAND AXLE SHAFT	
617608	LEFT HAND AXLE SHAFT	
617609	RIGHT HAND AXLE SHAFT	

ACCELERATOR

AIR CLEANER

BATTERY &
CHARGER

BODY & TRIM

CLUTCHES

DIRECTION
SELECTOR

ELECTRIC
MOTOR

ELECTRICAL
SYSTEM

ENGINE

FRONT
SUSPENSION
& STEERING

FUEL SYSTEM

REAR AXLE

REAR
SUSPENSION

SEATING

SPECIALTY
TOOLS

TOPS,
WINDSHIELDS
& PROTECTION



REAR SUSPENSION

SUB SECTION	PAGE
LEAF SPRINGS	209
MOUNTING PLATES & HARDWARE	210
SHOCK ABSORBERS	210-211

LEAF SPRINGS

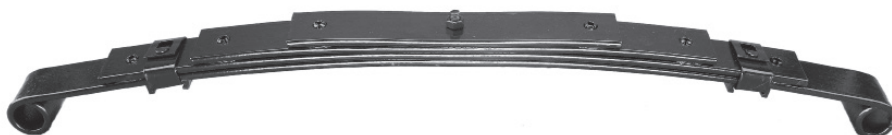

PART NUMBER	DESCRIPTION	VEHICLE
642461G01	LEFT HAND STRUT ASSEMBLY	2018+ EXPRESS 4X4
642461G02	RIGHT HAND STRUT & BEARING ASSEMBLY	
74207G03	440 RED REAR SPRING	2012+ EXPRESS; 2005-2012 SHUTTLE; 2005-2012 ST EXPRESS; 2012-2016 TERRAIN
605722	450 IVORY REAR LEAF SPRING	2012+ EXPRESS; 2012-2016 TERRAIN
605721	520 WHITE REAR LEAF SPRING	2012+ EXPRESS

ACCELERATOR

AIR CLEANER

BATTERY &
CHARGER

BODY & TRIM

CLUTCHES

DIRECTION
SELECTOR

ELECTRIC
MOTOR

ELECTRICAL
SYSTEM

ENGINE

FRONT
SUSPENSION
& STEERING

FUEL SYSTEM

REAR AXLE

**REAR
SUSPENSION**

SEATING

SPECIALTY
TOOLS

TOPS,
WINDSHIELDS
& PROTECTION

REAR SUSPENSION

MOUNTING PLATES & HARDWARE

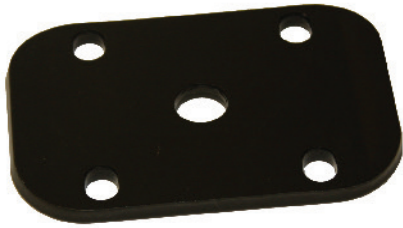

652246 ECOAT REAR SUSPENSION PLATE
2012+ EXPRESS
605977 RIGHT HAND REAR SUSPENSION PLATE
2012+ EXPRESS

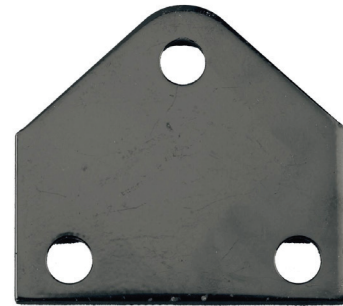

652258 ECOAT SPRING PLATE
2012+ EXPRESS



604961 SHACKLE PLATE
2012+ EXPRESS; 2012-2016 TERRAIN



652245 ECOAT SHACKLE PLATE
22012+ EXPRESS; 2018+ EXPRESS 4X4

SHOCK ABSORBERS



750117PKG 4 LEAF REAR SHOCK PACKAGE
2012+ EXPRESS

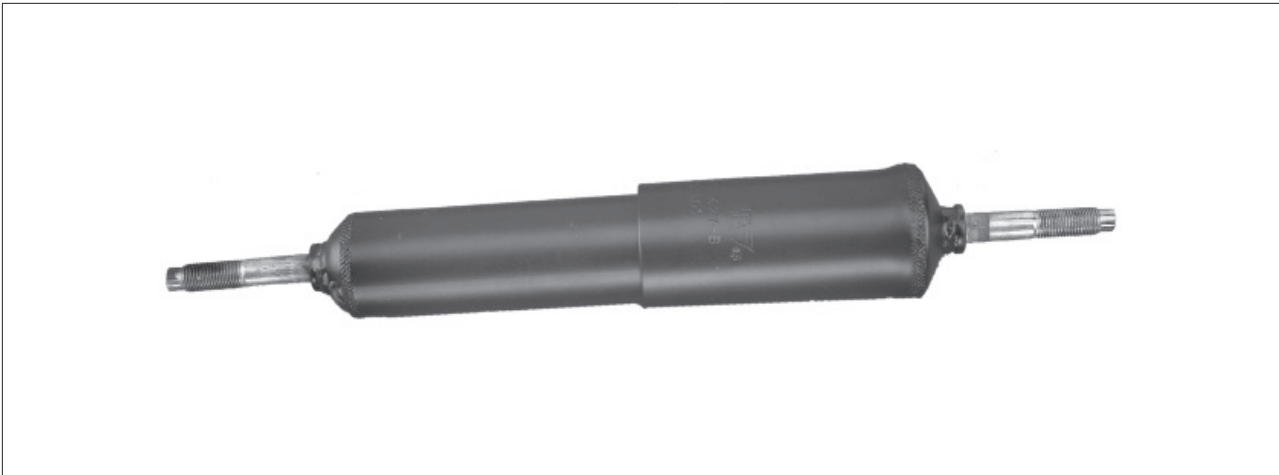

76419G01 SHOCK ABSORBER W/INTERNAL BUMPER
2012+ EXPRESS



76418G01 SHOCK ABSORBER
2012+ EXPRESS



642085 HEAVY DUTY REAR SHOCK ABSORBER
2012+ EXPRESS; 2012-2016 TERRAIN

ACCELERATOR

AIR CLEANER

BATTERY &
CHARGER

BODY & TRIM

CLUTCHES

DIRECTION
SELECTOR

ELECTRIC
MOTOR

ELECTRICAL
SYSTEM

ENGINE

FRONT
SUSPENSION
& STEERING

FUEL SYSTEM

REAR AXLE

**REAR
SUSPENSION**

SEATING

SPECIALTY
TOOLS

TOPS,
WINDSHIELDS
& PROTECTION



SEATING

SUB SECTION	PAGE
HIP RESTRAINTS	213
SEAT BOTTOMS	213-214
SEAT COMPONENTS	214-215
SEAT COVERS	216
SEAT PACKAGES	216

HIP RESTRAINTS



617644 PASSENGERS SIDE HIP RESTRAINT
2012+ EXPRESS

617645 DRIVERS SIDE HIP RESTRAINT
22012+ EXPRESS

SEAT BOTTOMS

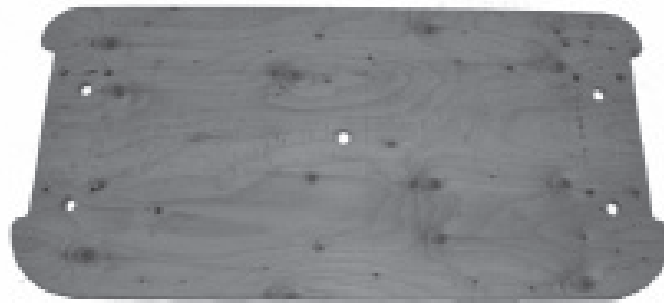

645493 SEAT BOTTOM BASE
2012+ EXPRESS

645492 SEAT BOTTOM BASE
2012+ EXPRESS



PART NUMBER	DESCRIPTION	VEHICLE
629269G1706	BLACK SHUTTLE SEAT BOTTOM ASSEMBLY	2012+ EXPRESS
629269G1703	TAN SHUTTLE SEAT BOTTOM ASSEMBLY	
628058G03	TAN FLIP SEAT BOTTOM ASSEMBLY	

ACCELERATOR

AIR CLEANER

BATTERY &
CHARGER

BODY & TRIM

CLUTCHES

DIRECTION
SELECTOR

ELECTRIC
MOTOR

ELECTRICAL
SYSTEM

ENGINE

FRONT
SUSPENSION
& STEERING

FUEL SYSTEM

REAR AXLE

REAR
SUSPENSION

SEATING

SPECIALTY
TOOLS

TOPS,
WINDSHIELDS
& PROTECTION

SEATING

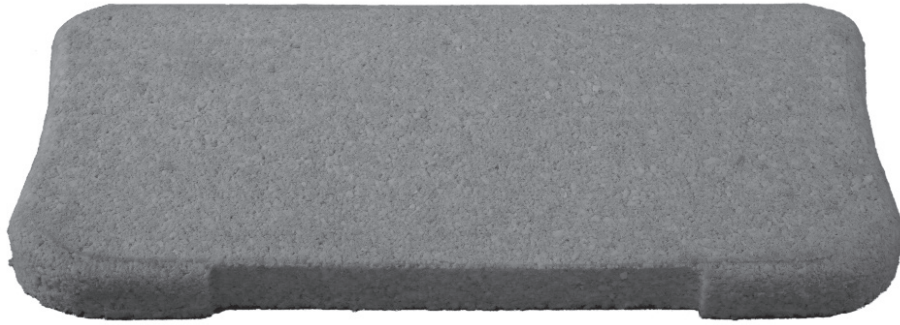

71603G02 SEAT BOTTOM FOAM
2012+ EXPRESS

SEAT COMPONENTS



PART NUMBER	DESCRIPTION	VEHICLE
634178	SEAT BACK SUPPORT WELDMENT	2012+ EXPRESS
71868G01	SEAT BACK SUPPORT WELDMENT	
615730	SEAT BACK SUPPORT WELDMENT	

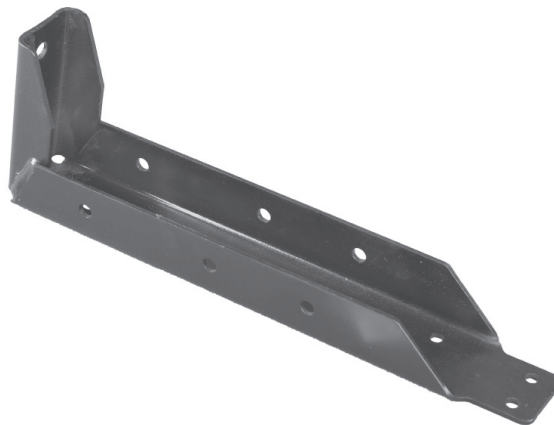

652243G03 SEAT BACK SUPPORT BRACKET
2012+ EXPRESS



PART NUMBER	DESCRIPTION	VEHICLE
70361G01	FOOTREST ASSEMBLY	2012+ EXPRESS
70633G01	FOOTREST WELDMENT	
634179	FOOTREST WELDMENT	

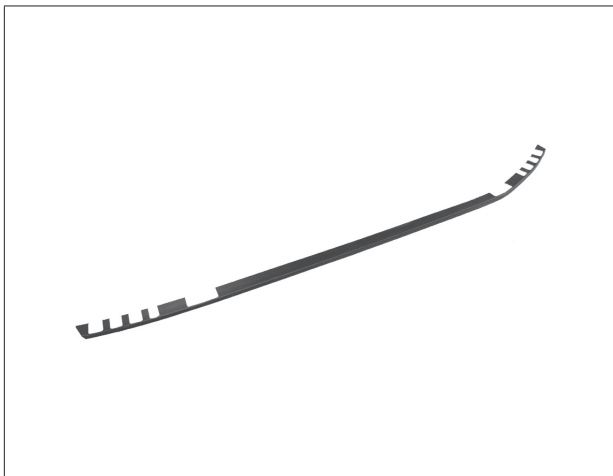

71012G01 SEAT BOTTOM TRIM
2012+ EXPRESS

ACCELERATOR

AIR CLEANER

BATTERY &
CHARGER

BODY & TRIM

CLUTCHES

DIRECTION
SELECTOR

ELECTRIC
MOTOR

ELECTRICAL
SYSTEM

ENGINE

FRONT
SUSPENSION
& STEERING

FUEL SYSTEM

REAR AXLE

REAR
SUSPENSION

SEATING

SPECIALTY
TOOLS

TOPS,
WINDSHIELDS
& PROTECTION

SEATING

SEAT COVERS

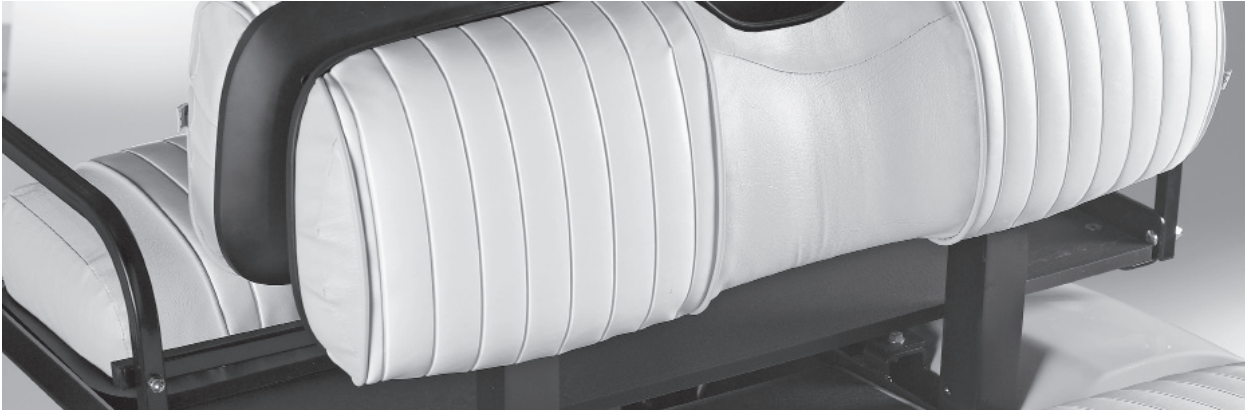

PART NUMBER	DESCRIPTION	VEHICLE
605529	PLASTIC SEAT BACK COVER	2018+ EXPRESS 4X4
615648	BLACK SEAT BOTTOM COVER	2012+ EXPRESS; 2018+ EXPRESS 4X4
611137	GRAY/BLACK REAR SEAT BOTTOM COVER	2012+ EXPRESS
615647	TAN REAR SEAT BOTTOM COVER	
71602G01	WHITE SEAT BOTTOM COVER	2012+ EXPRESS
71602G02	GRAY SEAT BOTTOM COVER	
71602G03	OYSTER SEAT BOTTOM COVER	
71602G04	TAN SEAT BOTTOM COVER	
71602G06	BLACK SEAT BOTTOM COVER	
750320PKG	TAN SEAT BOTTOM AND BACK COVER PACKAGE	2012+ EXPRESS

SEAT PACKAGES



PART NUMBER	DESCRIPTION	VEHICLE
750118PKG	WHITE SEAT BOTTOM AND BACK PACKAGE	2012+ EXPRESS
750119PKG	GRAY SEAT BOTTOM AND BACK PACKAGE	
750120PKG	OYSTER SEAT BOTTOM AND BACK PACKAGE	
750121PKG	TAN SEAT BOTTOM AND BACK PACKAGE	
750295PKG	BLACK SEAT BOTTON AND BACK PACKAGE	



SPECIALTY TOOLS

SUB SECTION	PAGE
DIAGNOSTIC TOOLS	218

DIAGNOSTIC TOOLS



664487 SAMSUNG SDI BATTERY DIAGNOSTIC TOOL
2020+ EXPRESS ELITE



TOPS, WINDSHIELDS AND PROTECTION

SUB SECTION	PAGE
82" TOP KITS	220
116" TOP KITS	220

TOPS, WINDSHIELDS & PROTECTION



82" TOP KITS

For use with Factory Rear Seat

TOP KITS/TOPS/STRUTS			
TOP KIT	TOP	STRUTS	COLOR
617950	607258	75488G01/617942/617943	BLACK
617947	607580	75488G01/617942/617943	WHITE
643404	643212	75488G01/617942/617943	TAN

82" COMPATIBLE WINDSHIELDS
607255
SPLIT/CLEAR
X
X
X

82" TOP KITS

For use with bed option

TOP KITS/TOPS/STRUTS			
TOP KIT	TOP	STRUTS	COLOR
607305	607258	75488G01/75487G01/75487G02	BLACK
607581	607580	75488G01/75487G01/75487G02	WHITE

82" COMPATIBLE WINDSHIELDS
607255
SPLIT/CLEAR
X
X

116" TOP KITS

For use with no rear seat or Factory Fixed/Flip Rear Seat

TOP KITS/TOPS/STRUTS			
TOP KIT	TOP	STRUTS	COLOR
610266	610263	610260/602741/602743	BLACK
610267	610264	610260/602741/602743	BEIGE
610268	610265	610260/602741/602743	WHITE
X	692088	610260/602741/602743	GREY

116" COMPATIBLE WINDSHIELDS
611100
SPLIT/CLEAR
X
X
X
X

INDEX

Part #	Pg
10001280	56 , 130
10001718	57 , 133
14651G1	43
18027G1	50
18287G3	73 , 203
18602G1	49 , 188
19932G1	64
20048G2	73 , 203
20377G11	79
20377G12	79
20468G1	51
21553G1	48
22288G1	51 , 190
24479G1	68
25523G3	59
25693G04	56
25854G01	17 , 163
25861G01	17
25864G09	52
25971G13	165
25971G18	165
25972G32	20
25972G40	20
26301G02	40
26301G03	40
26302G01	59
26479G01	40
26591G01	61
26626G01	55
26952G01	39
27166G04	34
27205G01	70
27205G02	70
27604G01	94
27739G01	53 , 128
27739G01	191
27758G01	37
27855G01	51
28109G01	23
28140G09	37
28140G14	37
28140G15	37
28462G01	60 , 133
28463G01	55
28463G01	130
28633G01	67
28659G01	75 , 143
28667G01	22
33636G05	48 , 187
33639G01	49

Part #	Pg
33639G02	49 , 188
33639G03	50 , 189
50641G1	78 , 206
600221	154
600225	110
600242	111
600249	105
600253	113
600257	113
600333	138 , 199
600462G01	167
601016	35
601085	78 , 206
601257	113
601258	113
601266	137
601621	109
601622	109
601624	143
601634	109
601679	105
601864	114
601865	114
602061	72 , 140
602061	203
602085	136
602101	112
602158	198
602176	198
602281	198
602288	198
602387	111
602388	112
602512	197
602529	101
602672	94
602741	94 , 220
602742	142
602743	94 , 220
602891	42
602896	103
602930	101
602981	68
603109	81
603203	159
603297	137
603322	137
603615	42 , 119
603816	137

Part #	Pg
604423	159
604424	159
604494	149
604511	125
604613	137
604614	137
604615	138
604961	83 , 210
605386	176
605393	176
605394	35 , 176
605529	154 , 216
605537	154
605548	152
605721	82 , 209
605722	82 , 209
605807	182
605809	182
605868	56 , 193
605935	108
605938	79
605977	210
606067	58 , 131
606067	193
606136	39 , 116
606138	39 , 116
606312	23
606354PKG	158
606390	58 , 131
606390	193
606391	59 , 194
606584	158
606937	94
606982	60 , 134
606982	194
607057	101
607131	111
607258	220
607305	220
607413	136
607438	126
607439	126
607441	114
607443	111
607450	126
607454	61 , 134
607454	194
607462	59 , 131
607462	193
607528	124

Part #	Pg
607530	128
607532	152
607533	111
607580	220
607581	220
607590	20
607591	20
607605	99
607653	152
607954	56 , 130
607955	56 , 130
607955	193
608007	154
608015	158
608089S	136
608198	158
608695PKG	158
608767	158
608808	112
608864	112
609083	52
609388	113
609603	136
609692	125
609801	101
610260	220
610263	220
610264	220
610265	220
610266	95 , 220
610267	95
610267	220
610268	95 , 220
610433	159
610434	159
610461	159
610462	159
610536	102 , 165
610583	123
611137	216
611218	21
611219	21
611271	136
611282	49 , 124
611282	188
611283	124 , 189
611724	150
611731	158
612104	111
612266	60 , 134

INDEX

Part #	Pg
612314	123
612556	79
612632	51 , 191
612756	52
612776	113
612823	207
612867	23 , 167
612889	99
613036G011	173
613036G019	173
613036G020	173
613036G035	173
613036G036	173
613036G037	173
613036G038	173
613036G039	173
613036G041	173
613036G042	173
613036G044	173
613036G051	173
613036G069	173
613036G076	173
613036G0A5	173
613227	158
613233	158
613236	19 , 101, 165
613237	19 , 101, 165
613273	33 , 174
613274	30 , 170
613304	19 , 165
614009	125
614009DELUXE	126
614034	137
614063	145
614208	79 , 145
614209	79 , 145
614252	45 , 121
614336	159
614337	159
614338	159
614344	159
614346	159
614347	159
614348	159
614378	30
614378	170
614535	123
614597	110
614756	145

Part #	Pg
614976	106
614979	106
614980	106
614981	106
614983	106
614984	106
614985	106
614986	106
614987	106
614988	106
614989	106
615132	154
615133	152
615169	154
615236	53 , 128, 191
615239	36
615551	190
615647	216
615648	216
615730	214
617074	48 , 123, 187
617121	198
617333	36
617590	106
617592	106
617608	207
617609	207
617620	29 , 169
617643	33 , 174
617644	86 , 152, 213
617645	86 , 152
617645	213
617867	177
617870	177
617942	220
617943	220
617947	220
617950	220
618329	138
618630	39 , 116, 180
618638	21
618653	33
618653	174
618888	177
618889	177
618955	126
619001	123
619102	189
619730G019	28

Part #	Pg
619730G020	28
619730G026	28
619730G031	28
619730G035	28
619730G037	28
619730G038	28
619730G041	28
619730G042	28
619730G043	28
619730G044	28
619730G051	28
619730G069	28
619730G076	28
619730G0A5	28
619996	102
620196	49
620327	78 , 146, 206
620329	78 , 146, 206
620348	78 , 146, 206
620349	78 , 146, 206
620418	48 , 188
620422	52 , 191
620880	158
622419	22 , 102, 166
622712	190
623949	40 , 180
624105	45 , 184
624111	149
624374	27 , 169
624607	33
625210	177
625211	37 , 177
625229G0101	86
625229G0103	86
625229G0106	86
625234G03	89
625234G06	89
625239	89
625272G011	172
625272G019	28 , 172
625272G020	28 , 172
625272G026	28
625272G031	28
625272G035	28 , 172
625272G036	172
625272G037	28 , 172
625272G038	28 , 172
625272G039	172
625272G041	28 , 172

Part #	Pg
625272G042	28 , 172
625272G043	28
625272G044	28 , 172
625272G051	28 , 172
625272G069	28 , 172
625272G076	28 , 172
625272G0A5	28 , 172
625290	94
625291	94
625292	94
625709	149
626455	108
626456	108
626459	109
626460	109
627117	50 , 189
627120	189
627121	170
627401G01	113
627401G02	113
627420	125
627426	81
627769	33
627889	103
627891	77 , 145
628023	34
628058G03	213
628532	29
628607	123
628660	184
629151	78 , 206
629269G0101	87
629269G0103	87
629269G0104	87
629269G0105	87
629269G0106	87
629269G1002	153
629269G1006	153
629269G1501	153
629269G1502	153
629269G1504	153
629269G1506	153
629269G1617	154
629269G1618	154
629269G1621	154
629269G1703	213
629269G1706	213
629269G1917	86
629269G1918	86

INDEX

Part #	Pg
629269G1921	86
629410	184
630187	106
630207	106
630307	159
630308	159
630309	159
630587	62 , 134, 194
630901	145
630970	62 , 134, 194
631070	124
631968	23
631972	62 , 134, 194
632862	103
633114	53 , 191
633599	77 , 205
633600	77 , 205
634178	88 , 214
634179	88 , 215
634329	29
634553G01	94
634553G02	94
634553G03	94
634567	166
634791	94
635005	94
635054G01	31 , 170
635054G02	31 , 170
635671	22 , 102, 166
637378	174
637535G01	171
637535G02	32 , 171
638383G01	197
638383G02	197
638948	138
639439	201
639807G01	114
639807G02	114
639876	79 , 147, 207
639881	79 , 147, 207
639948G01	36 , 177
639948G02	36 , 177
640261	166
640501G01	197
640501G04	197
641628	108
641632G02	35
641897G0001	153
641897G0002	153

Part #	Pg
641897G0004	153
641897G0006	153
642085	83 , 211
642444g01	110
642461G01	209
642461G02	209
643186	169
643212	220
643404	220
643973	105
644117	112
644300	116
644819G02	153
644876	50 , 189
644877	50 , 189
645088	112
645492	213
645493	213
645759G0011	106 , 107
645759G0019	106 , 107
645759G0020	106 , 107
645759G0036	106 , 107
645759G0037	106 , 107
645759G0039	106 , 107
645759G0041	106 , 107
645759G0042	106 , 107
645759G0044	106 , 107
645759G0051	106
645759G0076	106 , 107
645759G026	106 , 107
645759G031	106 , 107
645759G038	106 , 107
645759G052	106 , 107
646856	143
647282G17	154
647282G18	154
647282G21	154
648247	187
648313G19	178
648313G20	178
648313G36	178
648313G37	178
648313G38	178
648313G39	178
649240	126
649375	127
649376	127
649382	127
649383	127

Part #	Pg
649384	127
649385	127
649546	127
649547	127
649709	125
649816	124
650254	105
650353G0011	107
650353G0019	107
650353G0020	107
650353G0026	107
650353G0031	107
650353G0036	107
650353G0037	107
650353G0038	107
650353G0039	107
650353G0041	107
650353G0042	107
650353G0044	107
650353G0051	107
650353G0052	107
650353G0076	107
650443	105
650784	175
651410	102
652139G03	171
652243G03	214
652245	83 , 149, 210
652246	82 , 210
652254G03	23 , 167
652258	82
652258	210
653072	189
653213	22 , 102, 166
653214	22 , 102, 166
653299	127
654084G17	86
654084G18	86
654084G21	86
654759G0051	107
655131	189
655526	138
655529	138
656138	72
656139	72 , 203
656144	73 , 203
656325	111
656538	31
657280G03	110

Part #	Pg
657280G05	110
659008	189
659009	189
660379	62 , 134, 195
662248	75 , 142
663285	19 , 165
663303	138
663321	138
664487	92 , 156, 218
664620	170 ,
665954	24 , 103, 167
666996G04	52
667000G01	127
667000G02	127
667014g01	187
670468	77
670470	77 , 205
670781	113
671146	185
672557	190
672686	39 , 116
672891G01	124
676122	19
680373	59 , 132
680379	57 , 132
680380	57 , 133
680387	57 , 132
680638	121 , 185
680639	185
684128	57 , 132
684135	57 , 132
687855	94 , 159
689254	142
689255	142
689380	56 , 131, 193
689702	108
690087	176
692030	190
692088	220
695282	30
696008	55 , 130
696012	59 , 131
696497	56 , 132
696523	58
696533	55 , 130
696600	58 , 133
696602	58 , 133
696641	58 , 133
696855	24 , 103, 167

INDEX

Part #	Pg
699321G01	88
699321G03	88
699321G06	88
70041G01	69
70049G01	64
70179G01	69
70183G01	69
70192G01	69
70220G01	64
70221G01	64
70244G05	31, 171
70328G01	65
70360G01	67
70361G01	88, 215
70362G01	32
70451G01	32, 171
70505G01	81
70506G01	81
70540G02	83
70578G02	43
70580G01	66, 199
70589G01	65, 198
70603G01	67, 200
70604G01	67, 200
70607G01	66, 199
70610G03	66, 199
70633G01	88
70633G01	215
70663G03	32
70663G04	32
70663G06	32
70663G07	32
70664G03	64, 197
70673G03	65, 198
70673G04	65
70694G01	61, 194
70725G02	33, 174
70745G01	66
70758G05	66, 199
70802G01	198
70803G01	198
70876G02	70, 201
70895G01	66
70897G02	70, 201
70902G01	70, 201
70902G02	70, 201
70904G06	201
70930G01	198
70930G02	198

Part #	Pg
70931G01	198
70931G02	198
70942G03	65, 198
70961G01	67, 200
70964G01	68, 200
70965G01	68, 200
70989G03	82, 197
70990G03	82
70997G01	67, 199
71012G01	88, 215
71151G01	34, 175
71151G03	34, 175
71158G01	34, 176
71205G01	42, 119, 182
71318G01	27, 169
71320G01	27, 169
71451G02	29
71456G01	29, 169
71501G01	36
71502G01	36
71602G01	89, 216
71602G02	89, 216
71602G03	89, 216
71602G04	89, 216
71602G06	89, 216
71603G02	88, 214
71611G08	88
71664G07	88
71701G01	86
71702G01	86
71751G01	86
71751G03	86
71751G04	86
71751G07	86
71752G01	89
71753G01	89
71753G04	89
71753G07	89
71811G03	87
71853G01	75, 142
71868G01	214
72011G01	32
72056G01	79
72057G01	79
72084G01	72, 140, 203
72151G01	60
72178G01	60
72328G01	39
72368G01	55

Part #	Pg
72400G01	182
72763G02	177
72873G01	72
73030G02	35
73030G04	35
73030G06	35
73049G01	42, 182
73050G01	79, 207
73051G02	22
73051G05	20
73051G28	48
73060G01	52
73063G01	20
73120G25	45, 184
73120G36	185
73124G01	45
73124G03	46
73149G01	21
73195G01	43
73311G03	165
73327G01	46
73328G01	45, 184
73334G01	188
73348G04	190
73445G01	46
73500G01	77
74004G01	51
74139G04	88
74207G03	81, 209
74323G01	42, 182
74324G02	49
74604G01	201
74605G01	200
74612G01	205
74649G01	188
74730G01	201
750117PKG	83, 150, 210
750118PKG	90, 216
750119PKG	90, 216
750120PKG	90, 216
750121PKG	90, 216
750130PKG	75
750168PKG	36
750169PKG	36
750174PKG	31
750183PKG	37
750286PKG	30
750288PKG	48, 187
750290PKG	90

Part #	Pg
750295PKG	90, 216
750320PKG	90, 216
750332PKG	21
75033G01	75
750345PKG	21
750410PKG	40, 117
750412PKG	170
750440PKG	45, 184
750479PKG	128
750481PKG	113
750482PKG	113
750520PKG	34
750552PKG	94
750592PKG	170
750594PKG	37
750609PKG	72
750643PKG	73
750665PKG	154
750772PKG	114
750773PKG	114
750891PKG	128
750892PKG	128
750893PKG	128
75107G02	51
751251PKG	94
751252PKG	94
751263PKG	138
751462PKG	94
75197G04	88
75364G01	69
75459G01	175
75459G02	175
75459G03	175
75487G01	220
75487G02	220
75488G01	220
76418G01	83, 150, 211
76419G01	84, 211
PF10863	159

RETURN POLICY

A. ITEMS ELIGIBLE FOR RETURN

All returned items must be new, saleable, currently active, uninstalled, unused, and originally sold by the E-Z-GO Division of Textron Inc. (hereinafter "E-Z-GO"). Furthermore, all returns must be made within twelve (12) months of the original invoice date. Proof of purchase required for all returns. All kit items must be in the original packaging. The condition of returned items at the time of receipt by E-Z-GO must be such that they can be placed into stock and re-sold without any rework (i.e. re-boxing, touch up painting, etc.). Any item(s) determined by E-Z-GO to not be in acceptable condition when received by E-Z-GO may subsequently be returned by E-Z-GO to customer at the customer's expense. The following items are excluded from the this return policy, and are not eligible for return:

NON-RETURNABLE PARTS & ACCESSORIES	
CATEGORY	DETAILS
BATTERIES	Includes both 6 volt and 12 volt types
BODY COMPONENTS	Includes painted items such as bodies, cowls, body panels, tailgates, beds, and chrome/stainless steel accessories
BULK ITEMS	Includes items sold by the foot, yard, gallon or ounce, to include matting material, trim, wire, etc.
DECALS/LOGOS	Includes all items with adhesive backing such as number decals, club logos, safety decals, warning decals, instruction decals, etc
DISCONTINUED ITEMS	Includes all items with adhesive backing such as number decals, club logos, safety decals, warning decals, instruction decals, etc
HARDWARE	Includes all types of nuts, bolts, screws, washers, cotter pins, wire terminals and other fasteners.
LITERATURE	Includes all parts, owners, and service (repair) manuals.
LUBRICANTS	Includes oils, greases, and other petroleum based products.
NON-STOCK ITEMS	Includes items not normally carried in active Service Parts inventory, i.e. special order parts and vendor drop shipments.
PAINTS & CLEANERS	Includes aerosol sprays and paint pens.
SALE ITEMS	Includes all items sold at special or discounted pricing.
TIRES & WHEELS	Includes all tires, rims, lugs, center caps and tire & wheel assemblies.
ITEMS NOT ORIGINALLY BILLED THROUGH E-Z-GO P&A	Items originally sold as options/accessories with new units. There must be a valid invoice for parts purchases in our system showing when, and at what price, the item was originally purchased.
ELECTRICAL PARTS	Includes solenoids, switches, controllers, wiring, ESC components not previously listed, harnesses, lighting, audio components and any other battery powered accessories that may be damaged by fluctuations in current

We will not consider any obsolete, No Longer Available (NLA), excessive inventory or replaced by (R/B) items for return.

Please Note: Transit damage does not constitute a reason for the return of parts and accessories. This is the responsibility of the handling carrier and all claims must be filed with that carrier.

Items to be returned as a result of customer error must have a per-item retail value of \$5.00 or more, or an invoice total of \$25.00 or more



GENUINE OEM PARTS

© 2020 E-Z-GO Division of Textron Inc.
Part # 90002

⚠ Cancer and Reproductive Harm - www.P65Warnings.ca.gov.